

PG80MSUA

80% AFUE, Ultra Low NOx, Multi 18-Speed ECM, 4-Way Multipoise Gas Furnace

Product Data

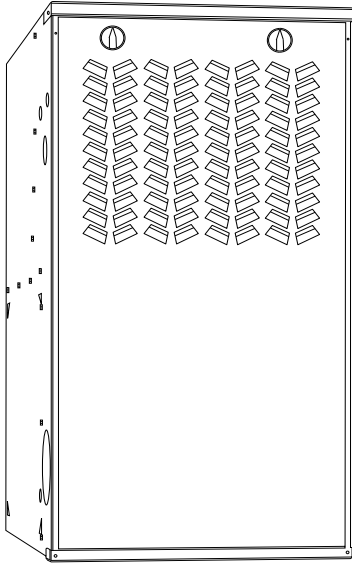

Representative drawing only. Some product models may vary.

A200137

! WARNING

This furnace is not designed for use in mobile homes, trailers, or recreational vehicles. Such use could result in property damage and/or death.

80 ULTRA LOW NOx GAS FURNACE

The PG80MSUA 4-way Multipoise Gas Furnaces offer features not found in other single-stage 80% gas furnaces. Improved serviceability with the 3 digit status display and NFC enabled board allowing setup via the service tech app. These models meet the nitrogen oxides (NOx) emission limit of 14 nanograms/joule for the South Coast Air Quality Management District and San Joaquin Valley Air Pollution Control District in California.

EFFICIENCY

- 80% AFUE
- 40K, 60K, 80K, 100K BTUh
- Ultra-low NOx emissions - meets the nitrogen oxides (NOx) emission limit of 14 nanograms/joule for the South Coast Air Quality Management District and San Joaquin Valley Air Pollution Control District in California.

TECHNOLOGY

- Single-stage gas valve
- Two-stage cooling capability
- Multi 18-Speed, Constant Torque (MCT) ECM blower motor
- Pre-mix burner with pilot free
- SiN Igniter for physical and electrical robustness and durability
- Variable speed inducer motor
- Stainless steel, tubular heat exchanger

PERFORMANCE

- Pre-mix burner with variable speed inducer
- Insulated blower compartment for quiet operation, and inner door for tighter sealing
- Draft safeguard switch designed to ensure proper furnace venting
- Dual Fuel compatible

DESIGN AND INSTALLATION

- Approved for installations up to 5,400 feet
- Versatile venting for tight-fit applications
- On-board NFC antenna makes setup a tap away when using the service technician app
- Factory shipped for natural gas, not convertible to propane
- Four-position furnace: Upflow, Horizontal Right, Horizontal Left, Downflow (with 6 different vent options)
- Cabinet air leakage less than 2.0% at 1.0 in. w.c. and cabinet air leakage less than 1.4% at 0.5 in. w.c. when tested in accordance with ASHRAE standard 193



Use of the AHRI Certified TM Mark indicates a manufacturer's participation in the program. For verification of certification for individual products, go to www.ahridirectory.org.



ISO 9001
Quality

A200103

DIMENSIONAL DATA

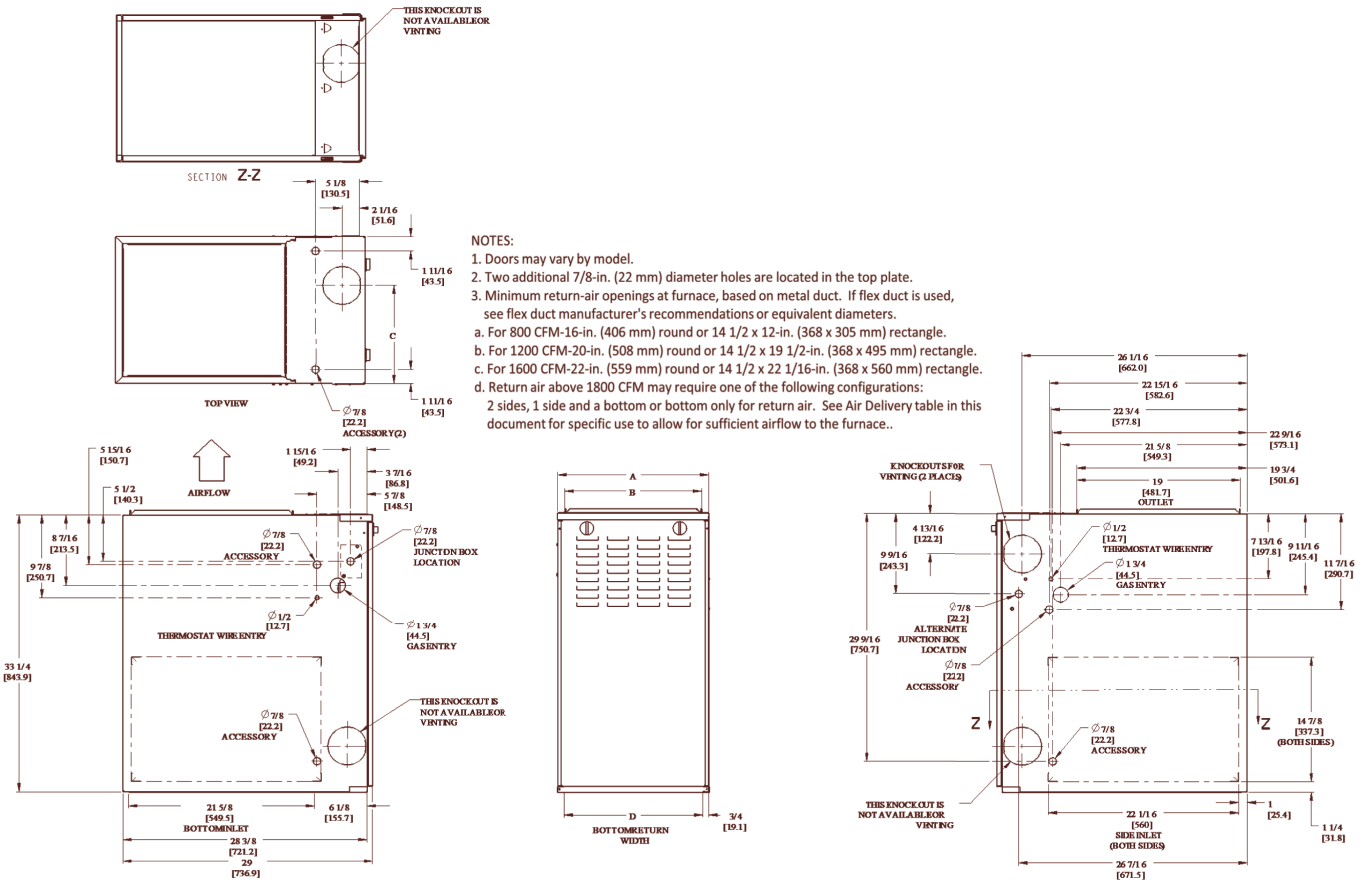

NOTES:

- Doors may vary by model.
- Two additional 7/8-in. (22 mm) diameter holes are located in the top plate.
- Minimum return-air openings at furnace, based on metal duct. If flex duct is used, see flex duct manufacturer's recommendations or equivalent diameters.
 - For 800 CFM-16-in. (406 mm) round or 14 1/2 x 12-in. (368 x 305 mm) rectangle.
 - For 1200 CFM-20-in. (508 mm) round or 14 1/2 x 19 1/2-in. (368 x 495 mm) rectangle.
 - For 1600 CFM-22-in. (559 mm) round or 14 1/2 x 22 1/16-in. (368 x 560 mm) rectangle.
- Return air above 1800 CFM may require one of the following configurations:
 2 sides, 1 side and a bottom or bottom only for return air. See Air Delivery table in this document for specific use to allow for sufficient airflow to the furnace..

NOTE: ALL DIMENSIONS IN INCH (MM)

U.S. ECCN: Not Subject to Regulation (N.S.R.)SD5674-4 REV A

A210783

Dimensions

FURNACE SIZE	A CABINET WIDTH IN. (MM)	B OUTLET WIDTH IN. (MM)	C TOP FLUE COLLAR ONLY IN. (MM)	D BOTTOM INLET WIDTH IN. (MM)	VENT CONNECTION IN. (MM) SIZE	SHIP WT. LB. (KG)
36040B	17-1/2 (445)	15-7/8 (403)	11-9/16 (294)	16 (406)	4 (102)	123 (56)
48060B	17-1/2 (445)	15-7/8 (403)	11-9/16 (294)	16 (406)	4 (102)	127 (58)
60080C	21 (533)	19-3/8 (492)	13-5/16 (338)	19-1/2 (495)	4 (102)	149 (68)
60100C	21 (533)	19-3/8 (492)	13-5/16 (338)	19-1/2 (495)	4 (102)	153 (69)

MODEL NUMBER NOMENCLATURE

1	2	3,4	5	6	7	8	9-10	11, 12, 13	14	15	16
Brand Identifier	Product	Base Effy.	Motor	Heating Stages	NOx Level	Major Series	Cooling Capacity	Heating Input	Width	Minor Series	Variations
P	G	92	E	S	A	A	36	040	A	A	A
P = Payne		G = Gas Furnace		80 = 80% AFUE 92 = 92% AFUE 95 = 95% AFUE 96 = 96% AFUE 97 = 97% AFUE 98 = 98% AFUE		C = Constant Airflow Variable-Speed (VCA) ECM V = Variable-Speed (VCT) PWM M = Multi 18-Speed Constant Torque (MCT) ECM		M = Modulating S = Single Stage T = Two-Stage		A = Standard L = Low NOx U = Ultra Low NOx	
		24 - 800 CFM 30 - 1000 CFM 36 - 1200 CFM 42 - 1400 CFM 48 - 1600 CFM 54 - 1800 CFM 60 - 2000 CFM 66 - 2200 CFM		026 = 26,000 BTU/h 040 = 40,000 BTU/h 060 = 60,000 BTU/h 080 = 80,000 BTU/h ---		A = 14.2" B = 17.5" C = 21.0" D = 24.5"		A B C ---		A = Standard Configuration	

A220583

CLEARANCES

WARNING

ELECTRIC SHOCK AND MOVING PARTS HAZARD
High voltage and rotating fan blades may be present in blower compartment when door switch is pressed. Keep hands clear.

WARNING

FIRE, EXPLOSION, ASPHYXIATION HAZARD

Improper adjustment, alteration, service, maintenance, or installation can cause serious injury or death.

Read and follow instructions and precautions in User's Information Manual provided with this furnace. Installation and service must be performed by a qualified service agency or the gas supplier.

CAUTION

Check entire gas assembly for leaks after lighting this appliance.

INSTALLATION

1. This furnace must be installed in accordance with the manufacturer's instructions and local codes. In the absence of local codes, follow the National Fuel Gas Code ANSI Z223.1 / NFPA54 or CSA B-149, 1 Gas Installation Code.

2. This furnace must be installed so there are provisions for combustion and ventilation air. See manufacturer's installation information provided with this appliance.

OPERATION

This furnace is equipped with manual reset limit switch(es) in burner compartment to protect against overheating conditions that can result from inadequate combustion air supply or blocked vent conditions.

1. Do not bypass limit switches.

2. If a limit opens, call a qualified serviceman to correct the condition and reset limit switch.

INSTALLATION

MINIMUM INCHES CLEARANCE TO COMBUSTIBLE CONSTRUCTION

This forced air furnace is equipped for use with natural gas at altitudes 0 - 5,400 ft (0 - 1646m).

This furnace is for indoor installation in a building constructed on site.

This furnace may be installed on combustible flooring in alcove or closet at minimum clearance as indicated by the diagram from combustible material.

This furnace may be used with a Type B-1 Vent and may be vented in common with other gas fired appliances.

Clearance arrows do not change with furnace orientation.

Clearance in inches

Vent Clearance to combustibles:
For Single Wall vents 6 inches (6 po).
For Type B-1 vent type 1 inch (1 po).

MINIMUM INCHES CLEARANCE TO COMBUSTIBLE CONSTRUCTION

DOWNFLOW POSITIONS:

† Installation on non-combustible floors only.
For installation on combustible flooring only when installed on a manufacture approved special base kit or manufacturer recommended coil assembly.

Ø 18 inches front clearance required for alcove.

* Indicates supply or return sides when furnace is in the horizontal position. Line contact only permissible between lines formed by intersections of the Top and Two Sides of the furnace jacket, and building joists, studs or framing.

345558-101 REV.B

A220905

The furnace should be sized to provide 100 percent of the design heating load requirement plus any margin that occurs because of furnace model size capacity increments. None of the furnace model sizes can be used if the heating load is 20,000 BTU or lower. Use Air Conditioning Contractors of America (Manual J and S); American Society of Heating, Refrigerating, and Air-Conditioning Engineers; or other approved engineering method to calculate heating load estimates and select the furnace. Excessive oversizing of the furnace may cause the furnace and/or vent to fail prematurely, customer discomfort and/or vent freezing.

Failure to follow these guidelines is considered faulty installation and/or misapplication of the furnace; and resulting failure, damage, or repairs may impact warranty coverage.

SPECIFICATIONS

UNIT SIZE		36040B	48060B	60080C	60100C
HEATING AND CAPACITY AND EFFICIENCY					
Input BTU ^h *		40,000	60,000	80,000	100,000
Output Capacity (BTU ^h) [†]		32,000	48,000	64,000	80,000
Certified Temperature Rise Range - °F (°C)		25-55 (14-31)	30-60 (17-33)	25-55 (14-31)	25-55 (14-31)
AFUE [‡]		80%			
AIRFLOW CAPACITY AND BLOWER DATA					
Rated Certified External Static Pressure	Heating	0.10	0.12	0.15	0.20
	Cooling	0.50	0.50	0.50	0.50
Airflow CFM @ Rated ESP (CFM) [‡]	Heating	740	985	1475	1765
	Cooling	300-1415	340-1845	330-2365	425-2290
Direct Drive Motor Type		Electronically Commutated Motor (ECM)			
Direct Drive Motor HP		1/2	3/4	1	1
Motor Full Load Amps		6.7	8.8	11.5	11.5
Heating Blower Control (Htg OFF-Delay)		Adjustable: 90, 120 (factory-set), 150, 180 seconds			
Cooling Blower Control (Clg OFF-Delay)		Adjustable: 90 (factory-set), 5, 30 seconds			
Blower Wheel Diameter x Width - In. (mm)		11x8 (279x203)	11x8 (279x203)	11x10 (279x254)	11x11 (279x279)
Air Filtration System		Field Supplied Filter			
Filter used for Certified Watt Data		325531-40**			
ELECTRICAL DATA					
Unit Volts-Hertz-Phase		115-60-1			
Operating Voltage Range	Min-Max	104-127			
Maximum Unit Amps		8.6	11.0	14.2	14.2
Unit Ampacity		11.2	14.2	18.2	18.2
Maximum Wire Length (Measure 1 way in Ft/M)		33/10.1	26/7.9	31/9.6	31/9.6
Minimum Wire Size	AWG	14	14	12	12
Max. Fuse/Ckt Bkr Size (Time-Delay Type Recommended)	Amps	15	15	20	20
Transformer Capacity (24 VAC output)		40VA			
External Control Power Available	Heating	12VA			
	Cooling	35VA			
GAS CONTROLS					
Gas Connection Size		1/2 in. NPT			
Gas Valve (Redundant)	Mfr	WhiteRodgers™			
Min. inlet pressure	(in. w.c.)	4.5 (Natural Gas)			
Max. inlet pressure	(in. w.c.)	13.6 (Natural Gas)			
Ignition Device		Silicon Nitride			
Factory installed orifice		3.35mm	18	10	6
CONNECTIONS					
Communication System		None			
Thermostat Connections		Y1, G, C, W, Y/Y2, R			
Accessory Connections		EAC-1 (115 VAC); HUM (24 VAC); 1-STG AC or 2-STG (via Y/Y2, Y1)			

*. Gas input ratings are certified for elevations to 2000 ft. (610 M). In USA, For elevations above 2000 ft (610 M), reduce ratings 2percent for each 1000 ft (305 M) above sea level. Refer to National Fuel Gas Code NFPA 54/ANSI Z223.1 Table F.4 or furnace installation instructions.

†. Capacity in accordance with U.S. Government DOE test procedures.

‡. Airflow shown is for bottom only return-air supply for the as-shipped speed tap. For air delivery above 1800 CFM, see Air Delivery table for other options. A filter is required for each return-air supply. An airflow reduction of up to 7 percent may occur when using the factory-specified 4-5/16-in. (110 mm) wide, high efficiency media filter.

** See Accessory List for part numbers available.

AIR DELIVERY - CFM

Air Delivery - CFM (with filter)

Unit Size	Airflow Setting	Default Setting	External Static Pressure (in. w.c.)									
			0.1	0.2	0.3	0.4	0.5	0.6	0.7	0.8	0.9	1
36040B	1	Const. Fan	610	525	440	365	300	230	165	-	-	-
	2		650	570	490	410	350	285	220	155	-	-
	3		705	630	555	480	415	355	295	235	170	-
	4	Heating	740	665	590	520	455	395	340	285	225	160
	5		815	735	670	600	540	475	420	370	315	260
	6		855	785	720	655	595	535	480	430	380	325
	7		915	850	785	725	665	605	550	495	450	405
	8		970	905	850	785	730	675	620	565	515	470
	9		1020	960	905	850	790	740	685	635	585	535
	10		1080	1025	970	920	865	810	760	710	665	615
	11		1140	1085	1035	980	930	880	830	785	735	690
	12		1200	1150	1095	1045	1000	950	905	855	810	765
	13		1265	1215	1160	1115	1070	1025	980	935	890	845
	14		1325	1280	1230	1180	1135	1095	1050	1005	960	920
	15		1385	1335	1285	1245	1200	1160	1120	1075	1035	990
	16	Cooling	1450	1405	1360	1315	1275	1235	1190	1155	1110	1070
	17		1520	1480	1435	1395	1355	1310	1275	1235	1195	1155
	18		1580	1540	1500	1455	1415	1375	1340	1300	1260	1225
48060B	1	Const. Fan	665	585	490	410	340	275	195	145	-	-
	2		755	680	600	520	445	385	325	255	190	140
	3		835	765	695	615	545	480	425	365	310	245
	4		905	840	775	710	635	570	515	460	405	355
	5	Heating	1000	935	875	815	750	690	620	570	520	470
	6		1050	995	935	880	820	755	700	645	595	550
	7		1130	1075	1020	970	915	855	800	745	690	645
	8		1200	1150	1100	1050	1000	945	890	840	785	735
	9		1285	1240	1190	1145	1095	1050	1000	945	895	850
	10		1365	1320	1275	1230	1185	1140	1100	1050	995	955
	11		1395	1355	1310	1265	1220	1175	1135	1090	1035	995
	12		1455	1415	1370	1330	1285	1245	1200	1160	1115	1070
	13		1545	1500	1465	1420	1380	1340	1305	1265	1225	1180
	14		1615	1580	1540	1500	1465	1425	1390	1350	1315	1275
	15		1695	1660	1625	1585	1550	1515	1480	1445	1405	1375
	16	Cooling	1775	1740	1705	1670	1635	1600	1570	1535	1500	1470
	17		1860	1825	1795	1760	1730	1695	1665	1635	1605	1575
	18		1970	1940	1910	1880	1845	1815	1780	1740	1695	1650
60080C	1	Const. Fan	745	630	520	420	330	240	155	-	-	-
	2		825	725	620	520	435	355	270	195	-	-
	3		925	835	740	650	560	485	415	340	260	195
	4		995	910	825	735	650	570	500	430	360	285
	5		1095	1015	935	855	770	695	620	555	495	430
	6		1210	1135	1065	990	915	840	770	705	635	580
	7		1290	1220	1150	1080	1010	940	875	810	740	685
	8		1390	1330	1265	1195	1130	1065	1000	940	875	815
	9	Heating	1505	1450	1390	1325	1270	1205	1145	1085	1025	970
	10		1595	1540	1480	1425	1370	1310	1250	1195	1140	1085
	11		1700	1645	1595	1540	1485	1435	1380	1325	1270	1220
	12		1795	1750	1700	1650	1595	1545	1495	1445	1395	1340
	13		1910	1865	1815	1770	1720	1675	1625	1580	1530	1485
	14		2020	1975	1930	1885	1840	1795	1750	1705	1660	1615
	15		2125	2080	2040	2000	1955	1915	1870	1830	1785	1745
	16	Cooling	2240	2200	2160	2120	2080	2040	2000	1965	1925	1885
	17		2335	2295	2260	2220	2185	2150	2110	2075	2040	2005
	18		2510	2475	2440	2400	2365	2325	2285	2230	2185	2130

Air Delivery - CFM (with filter) (Continued)

Unit Size	Airflow Setting	Default Setting	External Static Pressure (in. w.c.)									
			0.1	0.2	0.3	0.4	0.5	0.6	0.7	0.8	0.9	1
60100C	1	Const. Fan	865	745	640	525	425	315	170	-	-	-
	2		935	825	725	620	515	420	315	175	-	-
	3		1035	935	830	745	640	550	460	365	235	140
	4		1095	1000	900	815	725	630	545	455	360	240
	5		1205	1125	1035	945	870	780	695	620	540	455
	6		1290	1210	1125	1040	965	890	805	725	645	570
	7		1385	1310	1235	1155	1080	1010	940	860	785	710
	8	1495	1430	1360	1285	1215	1145	1080	1015	945	870	
	9	1585	1520	1455	1385	1315	1250	1185	1125	1065	995	
	10	1685	1625	1565	1505	1435	1370	1305	1250	1190	1135	
	11	1785	1725	1665	1605	1550	1485	1425	1365	1310	1255	
	12	Heating	1820	1765	1710	1655	1590	1530	1470	1410	1355	1305
	13		1880	1830	1775	1720	1665	1610	1550	1490	1435	1385
	14		1985	1930	1880	1830	1780	1730	1675	1620	1565	1515
	15	2090	2040	1990	1940	1895	1845	1795	1745	1690	1645	
	16	Cooling	2185	2140	2095	2045	2000	1960	1915	1865	1820	1770
	17		2285	2240	2195	2150	2110	2065	2025	1980	1940	1895
	18		2465	2420	2375	2335	2290	2235	2180	2125	2060	2000

NOTE:

1. A filter is required for each return-air inlet. Airflow performance included 3/4-in. (19 mm) washable filter media such as contained in a factory - authorized accessory filter rack. See accessory list. To determine airflow performance without this filter, assume an additional 0.1 in. w.c. available external static pressure.
2. **Adjust the blower airflow settings as necessary for the proper air temperature rise for each installation.**
3. Airflows over 1800 CFM require bottom return, two-side return, or bottom and side return. A minimum filter size of 20" x 25" (508 x 635 mm) is required.
4. For upflow applications, air entering from one side into both the side of the furnace and a return air base counts as a side and bottom return
5. The -- entry indicates unstable operating conditions.

Table 1 – Airflow Settings

Unit Size	Default Airflow Settings*		Designated Airflow Settings	
	Heating	Cooling	Heating	Constant Fan
36040B	4	16	(2-12)	(1-7)
48060B	5	16	(3-11)	(1-8)
60080C	9	16	(5-14)	(1-8)
60100C	12	17	(7-15)	(1-7)

*. Setting #1 is the default setting for Constant Fan.

TYPICAL WIRING SCHEMATIC

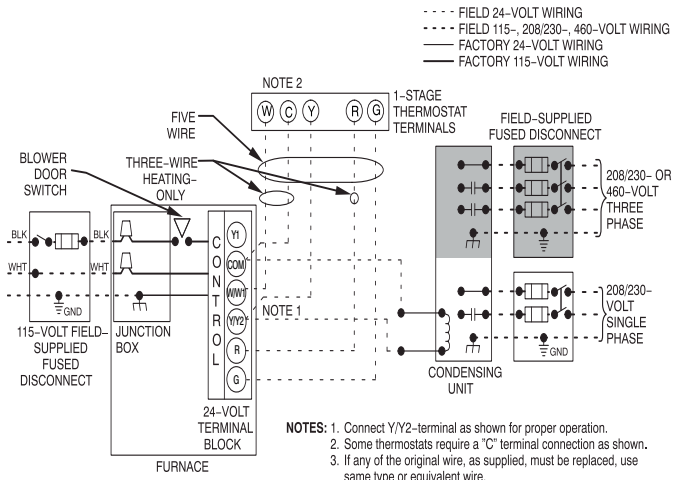

A200307

FURNACE CONTROL BOARD

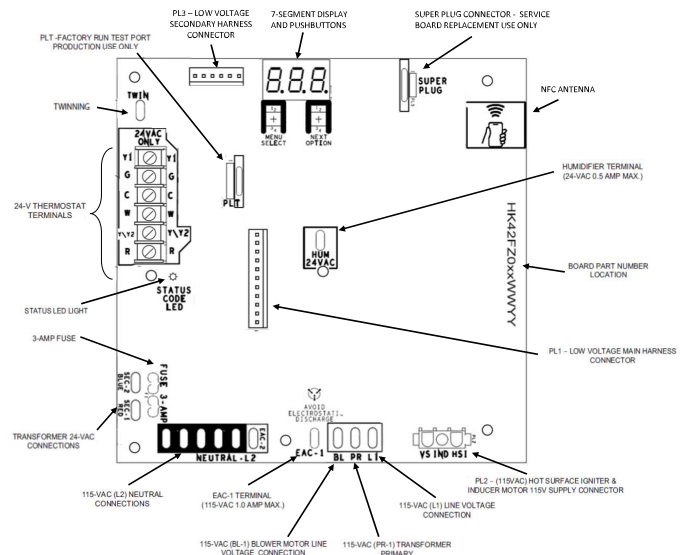

A220965

VENTING CONFIGURATIONS

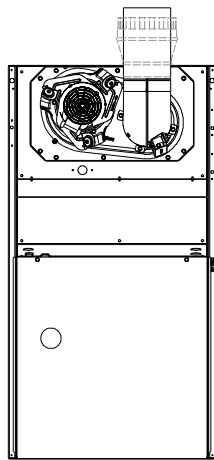

SEE NOTES: 1,2,4,7,8,9 on the page following

Upflow Application-Vent Elbow Up

A03208

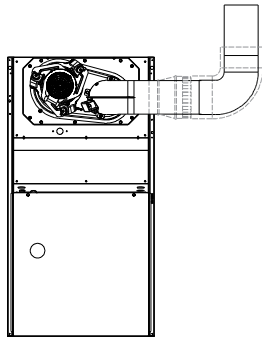

SEE NOTES: 1,2,3,4,7,8,9 on the pages following these figures

Upflow Application-Vent Elbow Right

A03209

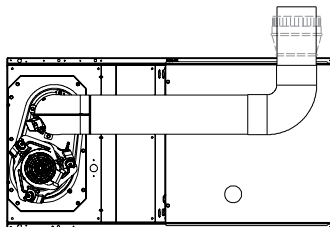

SEE NOTES: 1,2,4,5,7,8,9 on the page following these figures

Horizontal Right Application-Vent Elbow Right

A03214

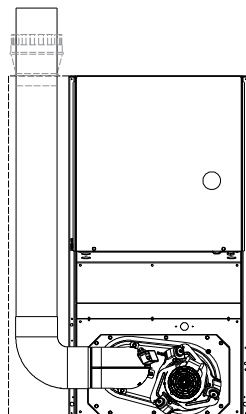

A03207

Downflow Application-Vent Elbow Left then Up

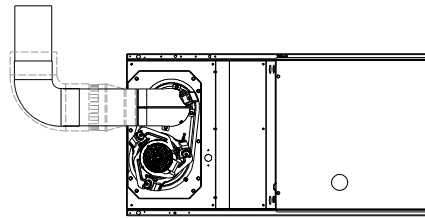

SEE NOTES: 1,2,4,7,8,9 on the page following these figures

Horizontal Left Application-Vent Elbow Left

A03213

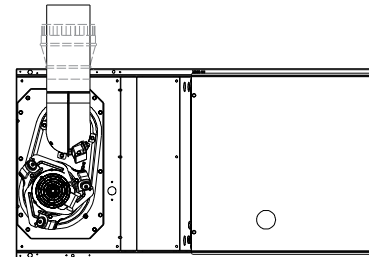

SEE NOTES: 1,2,4,5,7,8,9 on the page following these figures

Horizontal Left Application-Vent Elbow Up

A03215

Venting notes

1. For common vent, vent connector sizing and vent material: United States, latest edition of the National Fuel Gas Code (NFGC), NFPA54/ANSI Z223.1.
2. Immediately increase to 5-in. (127 mm) vent connector outside furnace casing when 5-in. (127 mm) vent connector required, refer to Note 1.
3. Side outlet vent for upflow and downflow installations must use Type B vent immediately after exiting the furnace, except when accessory Downflow Vent Guard is used in downflow position.
4. Type B vent where required, refer to Note 1.
5. 4-in. (102 mm) single wall vent must be used inside furnace casing and the Downflow Vent Guard Kit.
6. Accessory Downflow Vent Guard Kit required in downflow installations with bottom vent configuration.
7. Secure vent connector to furnace elbow with (2) corrosion-resistant sheet metal screws, space approximately 180° apart.
8. Secure all other single wall vent connector joints with (3) corrosion-resistant screws spaced approximately 120° apart.
9. Secure Type B vent connectors per vent connector manufacturer's recommendations.

ACCESSORIES

PART NO.	DESCRIPTION	36040B	48060B	60080C	60100C
ACG1625NCF*	External Filter Rack, 16 x 25"	X	X	-	-
ACG2025NCJ*	External Filter Rack, 20 x 25"	-	-	X	X
325531-402*	Washable filter, 3/4" x 16" x 25"*	X	X	-	-
325531-403*	Washable filter, 3/4" x 21" x 25"*	-	-	X	X
KGADA0101ALL	Coil Adapter Kits - No Offset	X	X	X	X
KGADA0201ALL	Coil Adapter Kits - Single Offset	X	X	X	X
KGADA0301ALL	Coil Adapter Kits - Double Offset	X	X	X	X
KGARP0301B17	Return Air Base (Upflow Applications) 17-1/2" wide	X	X	-	-
KGARP0301B21	Return Air Base (Upflow Applications) 21" wide	-	-	X	X
KGAFE0112UPH	Flue Extension	X	X	X	X
KGASB0201ALL	Combustible Floor Base (Not required when evaporator coil case is used for downflow)	X	X	X	X
KGBVG0101DFG	Downflow Vent Guard (Not required when vent is routed through cabinet)	X	X	X	X

*. Purchased through Replacement Components

DESCRIPTION	ACCESSORIES
HUMIDIFIER	Model HUM
HEAT RECOVERY VENTILATOR	Model HRV
ENERGY RECOVERY VENTILATOR	Model ERV
UV LIGHTS	Model UVL