

UC Open

Installation and Start-up Guide

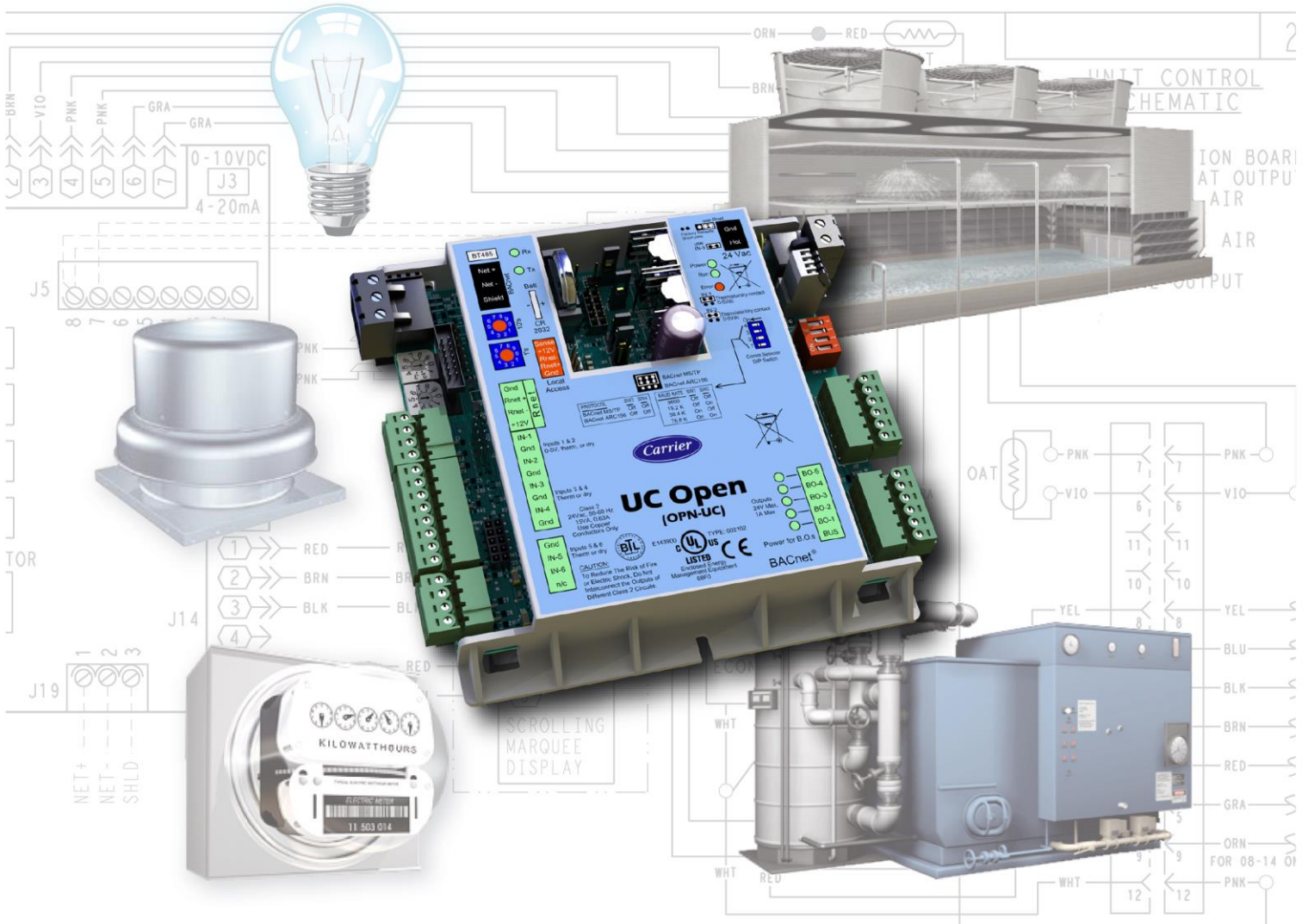



Verify that you have the most current version of this document from www.hvacpartners.com, the **Carrier Partner Community** website, or your local Carrier office.

Important changes are listed in **Document revision history** at the end of this document.

©2023 Carrier. All rights reserved.



Contents

Introduction	1
What is the UC Open controller?	1
Specifications	1
Safety considerations.....	3
Installing the UC Open	4
Mounting the UC Open	4
Wiring the UC Open for power	5
To wire for power.....	5
Addressing the UC Open	5
Wiring for communications.....	6
Wiring specifications for BACnet MS/TP and ARC156.....	6
To wire the controller to the BACnet network	6
Wiring inputs and outputs	7
Input wiring specifications	7
Inputs	8
Binary outputs	8
To wire inputs and outputs	8
Wiring devices to the UC Open's Rnet port.....	10
Rnet wiring specifications.....	11
To wire ZS sensors to the controller	11
To wire the Wireless Adapter for wireless sensors.....	12
To wire an Equipment Touch to the UC Open	14
To wire the TruVu™ ET Display	15
Installing the UC Open into the i-Vu® application	16
Local access to the UC Open	18
Troubleshooting	19
LED's	19
Serial number.....	20
To restore defaults.....	20
To replace the UC Open's battery.....	21
Compliance	22
FCC Compliance	22
CE and UKCA Compliance	22
BACnet Compliance.....	22
Appendix A: UC Open wire lists	23
UC Open wire list.....	23
Document revision history	24



Introduction

What is the UC Open controller?

The UC Open is a general purpose controller that provides the communications circuitry, non-volatile memory, and removable screw terminals for I/O connections.

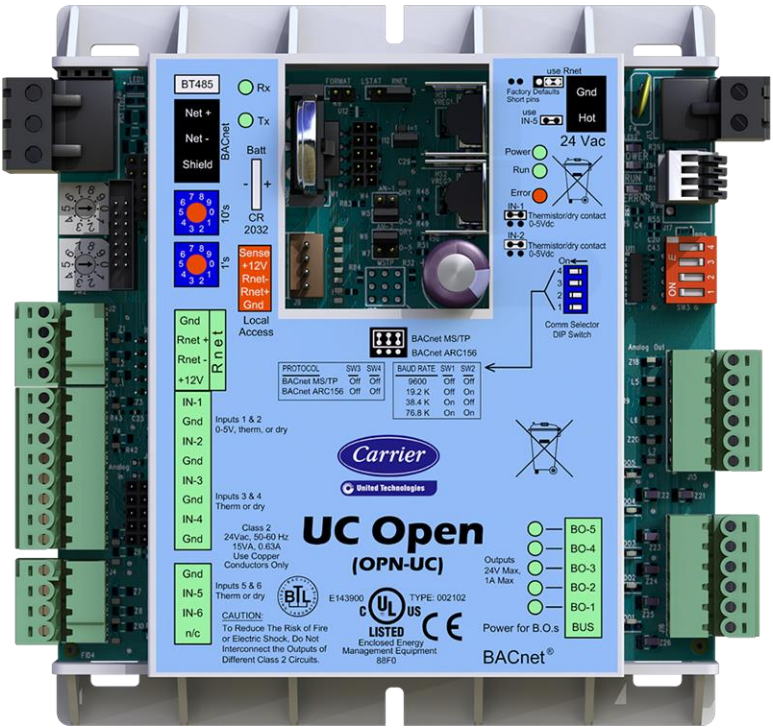



Specifications

Driver	drv_ucopen_std
Maximum number of control programs*	10
Maximum number of BACnet objects*	1050
Maximum number of third-party integration points using Snap*†	10

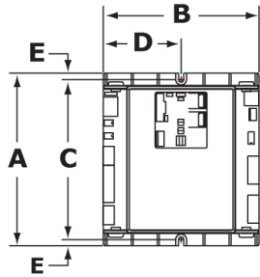
	* Depends on available memory † BACnet third-party integration points are not counted.
Power	24 Vac \pm 10%, 50–60 Hz 20 VA power consumption 26 Vdc (25 V min, 30 V max) Single Class 2 source only, 100 VA or less
BACnet Port	For communication with the controller network using BACnet ARC156 (156 kbps) or BACnet MS/TP (9600 bps – 76.8 kbps)
Rnet port	<ul style="list-style-type: none"> Supports up to 15 wireless and/or ZS sensors, and one Equipment Touch or TruVu™ ET Display Supplies 12 Vdc/210 mA power to the Rnet at an ambient temperature of 77 °F (25 °C) with a 24 Vac nominal power source. NOTE Ambient temperature and power source fluctuations may reduce the power supplied by the Rnet port. <p>NOTE If the total power required by the sensors on the Rnet exceeds the power supplied by the Rnet port, use an external power source. The Wireless Adapter, Equipment Touch, or TruVu™ ET Display must be powered by an external power source. See the specifications in each device's Installation and Start-up Guide to determine the power required.</p>
Local Access port	For system start-up and troubleshooting using Field Assistant
Inputs	6 inputs configurable for thermistor or dry contact. 1 and 2 are also configurable for 0–5 Vdc sensors. NOTE Input 5 has a maximum temperature of 140 °F (60 °C).
Input resolution	10 bit A/D
Binary outputs	5 binary outputs, dry relay contacts rated at 1 A max. @ 24 Vac/Vdc, configured normally open
Output resolution	10 bit D/A
Real time clock	Battery-backed real time clock keeps track of time in the event of a power failure
Battery	10-year Lithium CR2032 battery retains the following data for a maximum of 10,000 hours during power outages: control programs, editable properties, schedules, and trends.
Protection	<p>Built-in surge and transient protection for power and communications in compliance with EN61000-6-1.</p> <p>Incoming power and network connections are protected by non-replaceable internal solid-state polyswitches that reset themselves when the condition that causes a fault returns to normal.</p> <p>The power, network, input, and output connections are also protected against transient excess voltage/surge events lasting no more than 10 msec.</p> <p> CAUTION To protect against large electrical surges on serial EIA-485 networks, place a PROT485 at each place wire enters or exits the building.</p>
Status indicators	LEDs indicate status of communications, running, errors, and power.
Environmental operating range	0 to 130 °F (-18 to 54 °C), 0 to 90% relative humidity, non-condensing
Storage temperature range	-24 to 140 °F (-30 to 60 °C), 0 to 90% relative humidity, non-condensing
Physical	Rugged GE C2950HF Cyclopol plastic



Overall dimensions	A:	5-5/8 in. (14.3 cm)
	B:	5-1/8 in. (13 cm)
Mounting dimensions	C:	5-1/4 in. (13.3 cm)
	D:	2-9/16 in. (6.5 cm)
	E:	3/16 in. (.5 cm)
Panel depth	2 in. (51 mm)	
Weight	0.6 lbs (0.27 kg)	
BACnet support	Conforms to the BACnet Advanced Application Controller (B-AAC) Standard Device Profile as defined in ANSI/ASHRAE Standard 135-2012 (BACnet) Annex L, Protocol Revision 9	
Listed by	UL-916 (PAZX), cUL-916 (PAZX7), FCC Part 15-Subpart B-Class A, CE	
Compliance	Europe:  Mark, UK:  EN50491-5-2:2009; Part 5-2: EMC requirements for HBES/BACS used in residential, commercial and light industry environment RoHS Compliant: 2015/863/EU REACH Compliant Australia and New Zealand:  RCM Mark, AS/NZS IEC 61000-6-3	

Safety considerations

 **WARNING** Disconnect electrical power to the UC Open before wiring it. Failure to follow this warning could cause electrical shock, personal injury, or damage to the controller.

Installing the UC Open

- 1 *Mount the controller.* (page 4)
- 2 *Wire the controller for power.* (page 5)
- 3 *Set the controller's address.* (page 5)
- 4 *Wire the controller to the BACnet MS/TP or BACnet ARC156 network* (page 6).
- 5 *Wire inputs and outputs* (page 7).
- 6 *Wire devices to the controller's Rnet port.* (page 10)

Mounting the UC Open

 **WARNING**

When you handle the UC Open:

- Do not contaminate the printed circuit board with fingerprints, moisture, or any foreign material.
- Do not touch components or leads.
- Handle the board by its edges.
- Isolate from high voltage or electrostatic discharge.
- Ensure that you are properly grounded.

Screw the UC Open into an enclosed panel using the mounting slots on the coverplate. Leave about 2 in. (5 cm) on each side of the controller for wiring. Mounting hole dimensions 5 1/4" (13.3 cm) between mounting slot center lines.

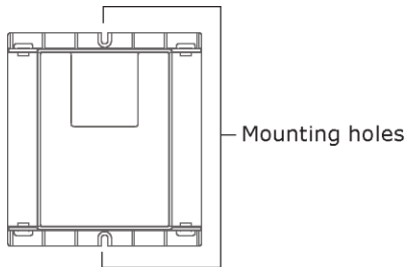

Wiring the UC Open for power

 **WARNING** Do not apply line voltage (mains voltage) to the controller's ports and terminals.

 **CAUTIONS**

- The UC Open is powered by a Class 2 power source. Take appropriate isolation measures when mounting it in a control panel where non-Class 2 circuits are present.
- Carrier controllers can share a power supply as long as you:
 - Maintain the same polarity.
 - Use the power supply only for Carrier controllers.

To wire for power

- 1 Remove power from the power supply.
- 2 Pull the screw terminal connector from the controller's power terminals labeled **Gnd** and **Hot**.
- 3 Connect the transformer wires to the screw terminal connector.

NOTE If using a grounded transformer, connect the ungrounded lead to the **Hot** terminal to avoid damaging the transformer.
- 4 Apply power to the power supply.
- 5 Measure the voltage at the UC Open's power input terminals to verify that the voltage is within the operating range of 21.6–26.4 Vac.
- 6 Insert the screw terminal connector into the UC Open's power terminals.
- 7 Verify that the **Power** LED is on and the **Run** LED is blinking.

Addressing the UC Open

You must give the UC Open an address that is unique on the network. You can address the UC Open before or after you wire it for power.

- 1 If the UC Open has been wired for power, pull the screw terminal connector from the controller power terminals labeled **Gnd** and **Hot**. The controller reads the address each time you apply power to it.
- 2 Using the rotary switches, set the controller address. Set the **Tens (10's)** switch to the tens digit of the address, and set the **Ones (1's)** switch to the ones digit.

EXAMPLE If the controller's address is 25, point the arrow on the **Tens (10's)** switch to 2 and the arrow on the **Ones (1's)** switch to 5.

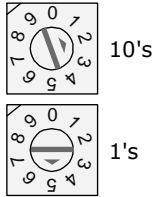

 **CAUTION** The factory default setting is **00** and must be changed to successfully install your UC Open.

Wiring for communications

The UC Open communicates using BACnet on the following types of network segments:

- MS/TP communicating at 9600 bps, 19.2 kbps, 38.4 kbps, or 76.8 kbps
- ARC156 communicating at 156 kbps

NOTE For more networking details, see the *Open Controller Network Wiring Installation Guide*.

Wiring specifications for BACnet MS/TP and ARC156

Cable:	22 AWG or 24 AWG, low-capacitance, twisted, stranded, shielded copper wire
--------	----------------------------------------------------------------------------

Maximum length:	2000 feet (610 meters)
-----------------	------------------------

 **WARNING** Do not apply line voltage (mains voltage) to the controller's ports and terminals.

To wire the controller to the BACnet network

- 1 Pull the screw terminal connector from the UC Open's power terminals labeled **24 Vac** and **Gnd (Return)**.
- 2 Check the communications wiring for shorts and grounds.
- 3 Connect the communications wiring to the controller's screw terminals labeled **Net +**, **Net -**, and **Shield**.

NOTE Use the same polarity throughout the network segment.

- 4 Set the communication type and baud rate.

For...	Set Communications Selection jumper to...	Set DIP switches 1 and 2 to...	Set DIP switches 3 and 4 to...
MS/TP	BACnet MS/TP	The appropriate baud rate. See the MS/TP Baud diagram on the controller.	Off/Off
ARC156	BACnet ARC156	N/A. Baud rate will be 156 kbps regardless of the DIP switch settings.	Off/Off

NOTE Use the same baud rate for all controllers on the network segment.

- 5 Wire the controllers on a BACnet MS/TP or BACnet ARC156 network segment in a daisy-chain configuration.
- 6 If the UC Open is at either end of a network segment, connect a BT485 to the UC Open.
- 7 Insert the power screw terminal connector into the UC Open's power terminals.
- 8 Verify communication with the network by viewing a Module Status report in the i-Vu® interface.

Wiring inputs and outputs



WARNING Do not apply line voltage (mains voltage) to the controller's ports and terminals.

See *Appendix A* (page 23) to print a blank wire list.

Input wiring specifications

Input	Maximum length	Minimum gauge	Shielding
0–5 Vdc	500 feet (152 meters)	22 AWG	100 feet (30.4 meters) unshielded 100 - 500 feet shielded
Thermistor Dry contact	500 feet (152 meters)	22 AWG	100 feet (30.4 meters) unshielded 100 - 500 feet shielded
Pulse counter TLO			100 - 500 feet shielded
ZS sensors	See <i>Wiring devices to the UC Open's Rnet port</i> (page 10).		
Wireless Adapter for wireless sensors			
Equipment Touch			
TruVu™ ET Display			

Inputs

The UC Open has inputs that accept the following signal types.

These inputs...	Support this signal type...	Description
All	Thermistor	Precon type 2 (10 kOhm at 77 °F/25 °C) Input voltage for IN-5: 1 to 2.52 Vdc Input voltage for all other inputs: 0.33 to 2.52 Vdc
All	Dry contact	A 3.3 Vdc wetting voltage detects contact position, resulting in a 0.3 mA maximum sense current when the contacts are closed.
IN-1, IN-2	0–5 Vdc	The input impedance of the UC Open is approximately 30 kOhm.
All	Pulse counter	Pulse counting up to 4 pulses per second. Minimum pulse width (on or off time) required for each pulse is 100 msec.

Binary outputs

The UC Open has 5 binary outputs. You can connect each output to a maximum of 24 Vac/26 Vdc. Each output is a dry contact rated at 1 A, 24 V maximum and is normally open.

To size output wiring, consider the following:

- Total loop distance from the power supply to the controller, and then to the controlled device
NOTE Include the total distance of actual wire. For 2-conductor wires, this is twice the cable length.
- Acceptable voltage drop in the wire from the controller to the controlled device
- Resistance (Ohms) of the chosen wire gauge
- Maximum current (Amps) the controlled device requires to operate

To wire inputs and outputs

- 1 Verify that the UC Open's power and communications connections work properly.
- 2 Pull the screw terminal connector from the controller's power terminals labeled **Gnd** and **Hot**.
- 3 Connect the input wiring to the screw terminals on the UC Open.

NOTES

- Connect the shield wire to the **GND** terminal with the ground wire.
- **IN-5** and **IN-6** share the **GND** terminal above **IN-5**.

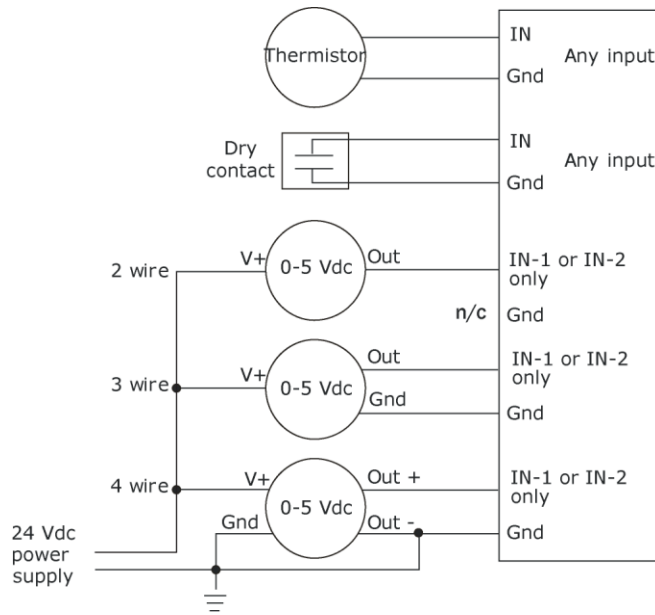

4 Set the appropriate jumpers on the UC Open.

To use...	For...	
IN-1 or IN-2	Thermistor Dry contact 0-5 Vdc	Set jumpers IN-1 or IN-2 to the type of signal the input will receive.
All	Thermistor Dry contact	Verify the IN-5 jumper is on.
Rnet Port	ZS sensors Wireless Adapter for wireless sensors Equipment Touch TruVu™ ET Display	Verify that the Rnet jumper to Rnet .

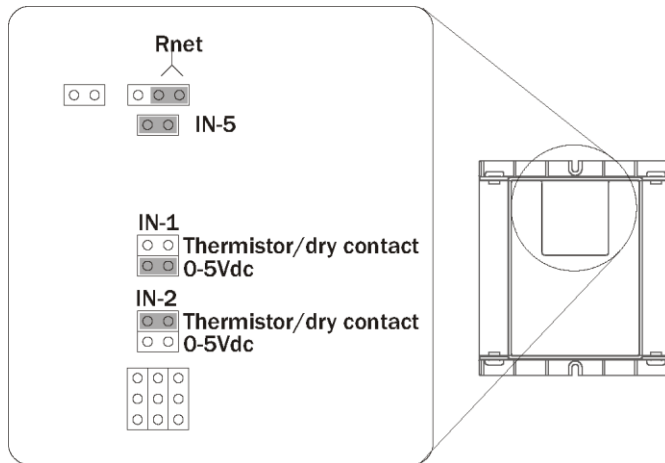

- 5 Connect the binary output wiring to the screw terminals on the UC Open and to the controlled device.

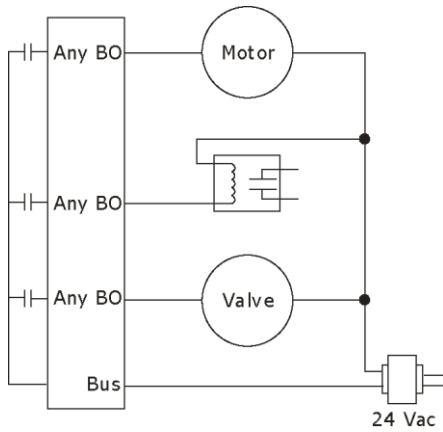

- 6 Insert the power screw terminal connector into the UC Open's power terminals.

Wiring devices to the UC Open's Rnet port

The Rnet communicates at a rate of 115 kbps and should be wired in a daisy-chain configuration.

Supports up to

- 15 wireless and/or ZS sensors (5 per control program)
- One Equipment Touch
- One TruVu™ ET Display

NOTES

- ZS sensors, a Wireless Adapter, and an Equipment Touch can share the Rnet, but not SPT sensors.
- The Wireless Adapter, Equipment Touch, or TruVu™ ET Display must be powered by an external power source.

Rnet wiring specifications

NOTE Use the specified type of wire and cable for maximum signal integrity.

Description	4 conductor, shielded or unshielded, CMP, plenum rated cable
Conductor	22 AWG (7x0096) bare copper if Rnet has only sensors
Maximum length	500 feet (152 meters)
Insulation	Low-smoke PVC (or equivalent)
Color Code	Black, white, green, red
Shielding	If shielded, Aluminum/Mylar shield (100% coverage) with TC drain wire, terminated at controller
UL temperature rating	32–167 °F (0–75 °C)
Voltage	300 Vac, power limited
Listing	UL: NEC CL2P, or better

To wire ZS sensors to the controller

ZS Sensors are thermistor-based temperature sensors that may optionally sense humidity, CO₂, or VOC. ZS Sensors are wired to the Rnet port on i-Vu® Open controllers. You can use the following ZS sensors:

- ZS Standard
- ZS Plus
- ZS Pro
- ZS Pro-F

NOTES

- The ZS CO₂ model uses 190 mA during sample period. Use auxiliary 12 Vdc, unless it is the only device on the Rnet port.
- A control program can use no more than 5 ZS Sensors
- SPT sensors cannot share the Rnet with other devices.
- For detailed instructions, see the *ZS Sensor Installation Guide*.

- 1 Remove power from the UC Open.
- 2 Partially cut, then bend and pull off the outer jacket of the Rnet cable(s). Do not nick the inner insulation. Strip about .25 inch (.6 cm) of the inner insulation from each wire.

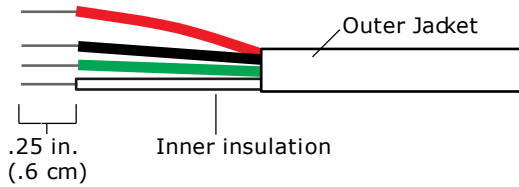

- 3 Wire each terminal on the sensor to the same terminal on the controller. See diagram below.

NOTE Carrier recommends that you use the following Rnet wiring scheme:

Connect this wire...	To this terminal...
Red	+12V
Black	Rnet-
White	Rnet+
Green	Gnd

- 4 Apply power to the UC Open.

To wire the Wireless Adapter for wireless sensors



WARNING Do not apply line voltage (mains voltage) to the Wireless Adapter.

The Carrier wireless sensors are available in 868, 902, and 928 MHz radio frequency. The sensors are thermistor-based temperature sensors that may optionally sense humidity.

Wireless sensors communicate through a Wireless Adapter, which is wired to the Rnet port of the controller.

REQUIREMENTS

- A v6.5 or later i-Vu® system
- v6-xx-xxx or later controller drivers

To configure the control program for the desired user interaction with the sensor, see the *Wireless Sensors Application Guide*. For detailed instructions, see the *Wireless Sensors Installation Guide*.

To wire, power, and mount the Wireless Adapter

NOTES

- The Wireless Adapter requires a 24 Vac power supply. It is not powered by the Rnet.
- If the Wireless Adapter will be:
 - Daisy-chained on the Rnet with ZS sensors, an Equipment Touch, or TruVu™ ET Display use the standard 4-conductor Rnet wiring.
 - The only device on the Rnet, you can use a 3-conductor cable instead of the standard 4-conductor Rnet cable.

- 1 Turn off the power to the controller that the Wireless Adapter will be wired to.
- 2 Partially cut, then bend and pull off the outer jacket of the Rnet cable(s). Do not nick the inner insulation.

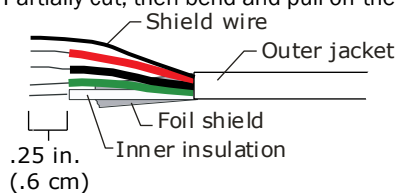

- 3 Strip about 0.25 inch (0.6 cm) of the inner insulation from each wire.
- 4 Wire the **Rnet +**, **Rnet -**, and **Gnd** terminals on the controller's **Rnet** port to the terminals of the same name on the Wireless Adapter's Rnet connector.

NOTE If using shielded wire, connect the shield wire and the ground wire to the **Gnd** terminal.

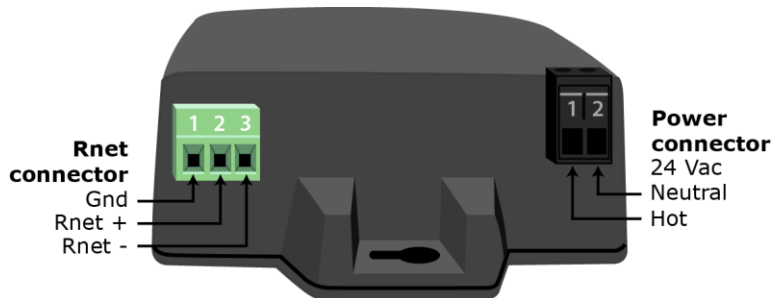

- 5 Wire the 24 Vac external power supply to the Wireless Adapter's power connector.
- 6 Mount the Wireless Adapter by inserting 2 screws through the mounting tabs on each end of the Wireless Adapter.
- 7 Apply power to the external power supply.
- 8 Verify that the LED on top of the Wireless Adapter is blinking. See "LED" below.
- 9 Turn on the controller's power.

LED

The blue LED on the top of the Wireless Adapter indicates the following:

If the LED is...	Then the device...
Off	Is not powered or there is a problem.
Blinking	Is working properly.
Steadily on	Has a problem. Do one of the following: <ul style="list-style-type: none"> • Cycle power to the device. • Insert a small screwdriver or paper clip into the hole next to the LED to reboot the device.

To wire an Equipment Touch to the UC Open

NOTES

- The Equipment Touch requires a 24 Vac power supply. It is not powered by the Rnet.
- If the Equipment Touch will be:
 - Daisy-chained on the Rnet with ZS sensors or a Wireless Adapter, use the standard 4-conductor Rnet wiring and follow the wiring instructions *To wire ZS sensors to the UC Open* (page 11).
 - The only device on the Rnet, you can use a 2-conductor cable instead of the standard 4-conductor Rnet cable and follow the instructions below.
- For complete Equipment Touch installation instructions including wiring diagrams, see the *Equipment Touch Installation and Setup Guide*.



CAUTION The UC Open can share a power supply with the Carrier controller as long as:

- The power supply is AC power.
- You maintain the same polarity.
- You use the power source only for Carrier controllers.

- 1 Turn **off** the UC Open's power.
- 2 Partially cut, then bend and pull off the outer jacket of the cable. Do not nick the inner insulation.

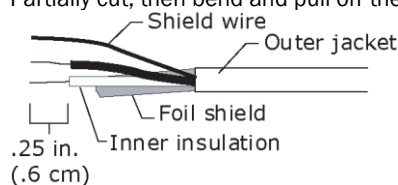

- 3 Strip about 0.25 inch (0.6 cm) of the inner insulation from each wire.
- 4 Wire the UC Open's **Rnet+** and **Rnet-** terminals to the terminals of the same name on the Equipment Touch's connector.

NOTE If using shielded wire, connect the shield wire and the ground wire to the **Gnd** terminal.

- 5 Turn **on** the UC Open's power.
- 6 Turn on the Equipment Touch.

To wire the TruVu™ ET Display

 **WARNING** Do not apply line voltage (main) - 24 Vdc power only.

Wiring power

Wire the TruVu™ ET Display **24V DC** connector to the 24 Vdc power supply using 2-conductor 18 AWG wire. Maximum distance 100 feet (30 meters).

 **CAUTION** The TruVu™ ET Display can share a power supply with the Carrier controller as long as:

- The power supply is DC power.
- You maintain the same polarity.
- You use the power source only for Carrier controllers.

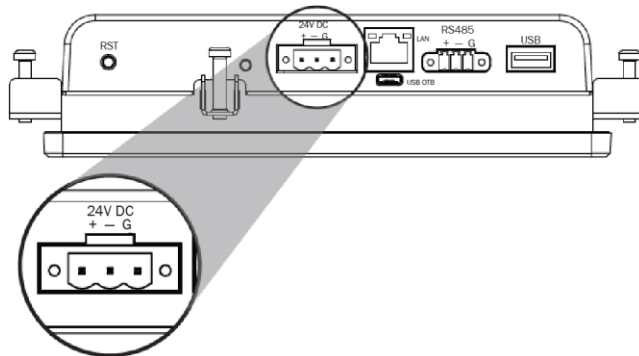

Wiring communication

- 1 Turn off the UC Open's power.
- 2 Wire the TruVu™ ET Display's **RS485** connector to the controller's **Rnet** port, **G** to **Gnd**, **+** to **Rnet +**, **-** to **Rnet -** using 2-conductor 22 AWG wire with a maximum distance of 500 feet (152 meters).

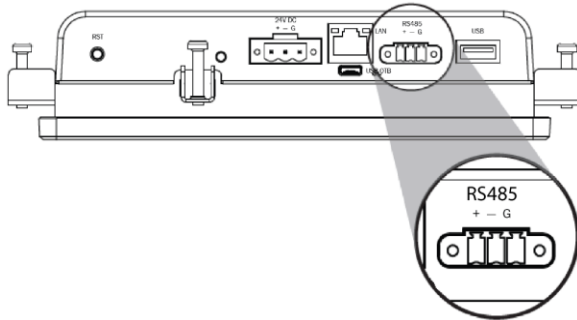

- 3 Turn on the UC Open's power.

For complete TruVu™ ET Display installation instructions, see the *TruVu™ ET Display Installation and Start-up Guide*.

Installing the UC Open into the i-Vu® application

You must complete the following procedures to successfully install your UC Open into an i-Vu® Control System. Use the Help in the referenced software for detailed descriptions of these procedures.

EquipmentBuilder or Snap

- 1 Use EquipmentBuilder or Snap to create control program(s) for your UC Open.
- 2 If applicable, print the Sequence of Operation, which includes the points list.
NOTE You can create a points list under **Reports** in the i-Vu® application or Field Assistant after installing your control program.

This Installation Guide

- 1 Prepare a wire list using the points list. Refer to *Appendix A* (page 23).
- 2 Use the wire list and the following installation procedures to install and wire I/O points to your UC Open.

The i-Vu® or Field Assistant application

- 1 Upload the controller to the database by selecting the router in the navigation tree.
- 2 Select **Devices > Manage** tab.
- 3 Select the controller in the list on the page and click **Upload**.
- 4 If you are adding a new control program, click **Add Control Program**. A dialog window appears.

- 5 Enter a name for your control program in **Display Name** and select your controller in the **Controller** drop-down list.

NOTES

- If you already have the maximum number of control programs for a controller, it will not appear in the list.
 - Optional: You can change the control program's **Reference Name** if needed.
- 6 Do one of the following:

If the control program is...

In the **Control Program** drop-down list Select the control program.

Not in the **Control Program** drop-down list

- a. Click **Add New**.
- b. Browse to select the control program.
- c. Click **Open**.
- d. Click **Continue**.
- e. Click Close.

- 7 To upload a graphic, click **Add New** under **Views** and browse to your .view file.
- 8 Click **Continue**. When message appears **File added successfully**, click **Close**.
- 9 Click **Close** again.
- 10 Right-click on the programmable controller in the controller list and select **Check Status** from the list. The status of the controller should say **File Mismatch**.
- 11 Click the **Download All Content** button.
- 12 Assign channel numbers to the physical points by selecting the controller in the navigation tree and going to **Properties** page > **I/O Points** tab.
- 13 Configure the controller on the **Properties** page > **Control Program** tab.
- 14 Check out and commission the equipment.

Local access to the UC Open

You can use the following items as a local user interface to an Open controller. These items let you access the controller information, read sensor values, and test the controller.

Connect...	To the controller's...	For...
Field Assistant ¹ application	Local Access port	Temporary user interface for start-up
Equipment Touch ² touchscreen device	Rnet port	Temporary or permanent user interface for start-up

¹ Requires a USB Link (Part #USB-L)

² See the *Equipment Touch Installation and Setup Guide* for detailed instructions.

 **CAUTION** If multiple controllers share power but polarity was not maintained when they were wired, the difference between the controller's ground and the computer's AC power ground could damage the USB Link and the controller. If you are not sure of the wiring polarity, use a USB isolator between the computer and the USB Link. Purchase a USB isolator online from a third-party manufacturer.

These are accessory items that do not come with the controller.

Troubleshooting

If you have problems mounting, wiring, or addressing the UC Open, contact Carrier Control Systems Support.

NOTE To help you troubleshoot, obtain a Module Status (Modstat) from the controller and review the System Error and Warning details.

LED's

The LED's indicate if the controller is speaking to the devices on the network. The LED's should reflect communication traffic based on the baud rate set. The higher the baud rate the more solid the LED's become.

Verify the LED patterns by cycling power to the controller and noting the lights and flashes.

LEDs	Status
Power	Lights when power is being supplied to the controller. NOTE The UC Open is protected by internal solid state Polyswitches on the incoming power and network connections. These Polyswitches are not replaceable, but they will reset themselves if the condition that caused the fault returns to normal.
Rx	Lights when the controller receives data from the network segment; there is an Rx LED for Ports 1 and 2.
Tx	Lights when the controller transmits data from the network segment; there is an Rx LED for Ports 1 and 2.
Run	Lights based on controller health.
Error	Lights based on controller health.

The **Run** and **Error** LED's indicate controller and network status.

If Run LED shows...	And Error LED shows...	Status is...
1 flash per second	1 flash per second, alternating with the Run LED	The controller files are archiving. Archive is complete when Error LED stops flashing.
2 flashes per second	Off	Normal
2 flashes per second	2 flashes, alternating with Run LED	Five minute auto-restart delay after system error
2 flashes per second	3 flashes, then off	The controller has just been formatted
2 flashes per second	4 flashes, then pause	Two or more devices on this network have the same network address
2 flashes per second	1 flash per second	The controller is alone on the network

If Run LED shows...	And Error LED shows...	Status is...
2 flashes per second	On	Exec halted after frequent system errors, due to: <ul style="list-style-type: none"> • Controller halted • Program memory corrupted • One or more programs stopped
5 flashes per second	On	Exec start-up aborted, Boot is running
5 flashes per second	Off	Firmware transfer in progress, Boot is running
7 flashes per second	7 flashes per second, alternating with Run LED	Ten second recovery period after brownout
14 flashes per second	14 flashes per second, alternating with Run LED	Brownout
On	On	Failure. Try the following solutions: <ul style="list-style-type: none"> • Turn the UC Open off, then on. • Download memory to the UC Open. • Replace the UC Open.

NOTE If you resolve the issue but the **Error** LED does not turn off, cycle power to the controller.

Serial number

If you need the UC Open's serial number when troubleshooting, the number is on a sticker on the back of the main controller board.

To restore defaults



WARNING This erases all archived information and user-configuration settings. You will have to reconfigure all custom settings. It is recommended to restore the factory defaults only under the guidance of Carrier Control Systems Support.

To erase volatile memory data and restore factory default configuration settings:

- 1 Turn off the UC Open's power switch.
- 2 Put the **Factory Defaults** jumper on.
- 3 Turn on the UC Open's power switch.
- 4 Remove the **Factory Defaults** jumper.

To replace the UC Open's battery

To determine when to replace the battery, remove power and measure the voltage. If the voltage is below 2.9 volts, you need to replace the battery.



CAUTION Power must be **ON** to the UC Open when replacing the battery, or your date, time, and trend data will be lost.

- 1 Remove the battery from the controller, making note of the battery's polarity.
- 2 Insert the new battery, matching the battery's polarity with the polarity indicated on the UC Open.

Compliance

FCC Compliance

This equipment has been tested and found to comply with the limits for a Class A digital device, pursuant to Part 15 of the FCC Rules. These limits are designed to provide reasonable protection against harmful interference when the equipment is operated in a commercial environment. This equipment generates, uses, and can radiate radio frequency energy and, if not installed and used in accordance with the instruction manual, may cause harmful interference to radio communications. Operation of this equipment in a residential area is likely to cause harmful interference in which case the user will be required to correct the interference at his own expense.



CAUTION Changes or modifications not expressly approved by the responsible party for compliance could void the user's authority to operate the equipment.

CE and UKCA Compliance





WARNING This is a Class B product. In a light industrial environment, this product may cause radio interference in which case the user may be required to take adequate measures.

BACnet Compliance

Compliance of listed products to requirements of ASHRAE Standard 135 is the responsibility of BACnet International. BTL® is a registered trademark of BACnet International.

Appendix A: UC Open wire lists

UC Open wire list

Open System Network UC Universal Controller								
Project Name:				Controller:				
Location:				Network Number:				
				MAC Address:				
 Thermistor/dry contact  0-5Vdc								
Point/ Cable#	Inputs (+)	(G)	Input Type	Jumper Position of Pins	I/O	Sensor code	Equipment Name	Point Name
	IN - 1	GND	Therm/Dry Contact	Upper	IN - 1			
	IN - 1	GND	0-5Vdc	Lower				
	IN - 2	GND	Therm/Dry Contact	Upper	IN - 2			
	IN - 2	GND	0-5Vdc	Lower				
	IN - 3	GND	Therm/Dry Contact	N/A	IN - 3			
	IN - 4	GND	Therm/Dry Contact	N/A	IN - 4			
	IN - 5*	GND	Therm/Dry Contact	N/A	IN - 5			
	IN - 6	GND	Therm/Dry Contact	N/A	IN - 6			
*Input 5 has a maximum temperature of 140°F (60°C).								
Point/ Cable#	Binary Outs (+)	COM	B-Output Type	Jumper Position of Pins	I/O	Sensor code	Equipment Name	Point Name
	BO - 1	BUS	N.O.	N/A	BO - 1			
	BO - 2	BUS	N.O.	N/A	BO - 2			
	BO - 3	BUS	N.O.	N/A	BO - 3			
	BO - 4	BUS	N.O.	N/A	BO - 4			
	BO - 5	BUS	N.O.	N/A	BO - 5			

Document revision history

Important changes to this document are listed below. Minor changes such as typographical or formatting errors are not listed.

Date	Topic	Change description	Code*
9/1/23	Specifications	Added Australia and New Zealand to Compliance	X-PM-JW-R-BH
7/21/22	Specifications	Added Compliance row	X-PM-AB-R-BH
	CE and UKCA Compliance	Added UKCA compliance	
9/21/21	Wiring devices to the UC Open's Rnet port	Removed hybrid wiring configuration for Rnet port	X-TS-AK-E
8/24/20	Cover What is the UC Open?	Logo change.	C-D
1/25/19	Wiring devices to the UC Open's Rnet port	Removed star configuration from the first paragraph.	X-TS-TS-O
	Specifications	Added surge CAUTION to Protection specification.	X-TS-AK-E-CC
10/29/18	Wiring inputs and outputs > Input wiring specifications and To wire inputs and outputs	Removed SPT sensor from Input wiring table, added TruVu™ ET Display, and referred user to the device's Installation and Start-up Guide.	C-D
	Wiring devices to the UC Open's Rnet port	Combined overview and wiring on the zone sensors and touchscreen devices. Added TruVu™ ET Display.	C-D
	Specifications	Reworded Rnet port specification and added power supplied by Rnet port. Added first paragraph to Protection specification.	X-H-JS-O
2/24/17		Changed all "WS" to "wireless".	C-D
1/18/17	Wireless sensor overview To install the Wireless Adapter for Wireless sensors	New topics	C-D
	Wiring devices to the UC Open's Rnet port	Added Wireless Adapter, wireless sensors	C-D
	Input wiring specifications	Added Wireless Adapter for wireless sensors	C-D
	To wire the controller to the network	Added BACnet ARC156 connection information.	C-D
	Wiring for communications	Changed from Wiring the UC Open to the MS/TP network	C-D
	Specifications	Added BACnet ARC156 and updated Rnet port information to include Wireless Adapter.	C-D
	Cover What is the UC Open?	Changed to latest controller image.	C-D
2/22/16	Local access to the UC Open	Added USB Link wiring caution.	C-TS-RD-E-JH
8/4/14	Specifications	Maximum number of BACnet third-party integration points using Snap - changed to unlimited, depending on memory Power - removed references to BACview Rnet port - added Equipment Touch and removed BACview Rnet port - added note that number of possible ZS sensors you can have with an Equipment Touch is 15 Local Access port - removed BACview, added Equipment Touch	C-D-LJ-O
	Wiring devices to the Rnet port	Changed from "Wiring a communicating zone sensor to the UC Open" Removed BACview	
	Connecting an SPT sensor	Removed BACview and added Equipment Touch	
	To wire an Equipment Touch to the UC Open	New topic	
	BACview devices	Removed references and topics	

Important changes to this document are listed below. Minor changes such as typographical or formatting errors are not listed.

Date	Topic	Change description	Code*
	Local Access to the UC Open	Removed BACview and added Equipment Touch	
	To wire the Equipment Touch to the UC Open	Added Caution to maintain polarity and use the power supply only for Carrier controllers	C-TS-RD-E
	Restore factory defaults	Added information on using the Factory Defaults jumper	C-D-LJ-E-RD

* For internal use only



Carrier ©2023 · Catalog No. 11-808-464-01 · 9/1/2023