

Variable speed drives Altivar Process ATV600

Catalog

January 2017



Quick access to Product information

Select your Catalogue, your Training

Digi-Cat

The complete digital catalogue for industrial automation



Makes your choice easy every day, everywhere!



With just 3 clicks, you can reach the 7,000 pages of the Industrial Automation & Control catalogue, in both English and French.

- Digi-Cat is available on a USB key (for PC). To get your Digi-Cat, please contact your local center
- Download Digi-Cat from this address:

<http://digi-cat.schneider-electric.com/download.html>

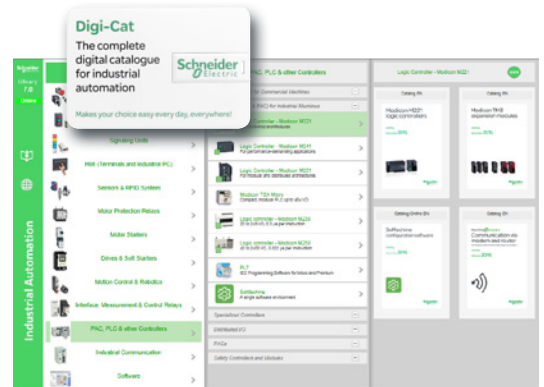

Find your training

- Find the right training for your needs
- Locate the training center with the selector tool, using this address:

<http://www.schneider-electric.com/b2b/en/services/training/technical-training.jsp>

then click on

Find your training center

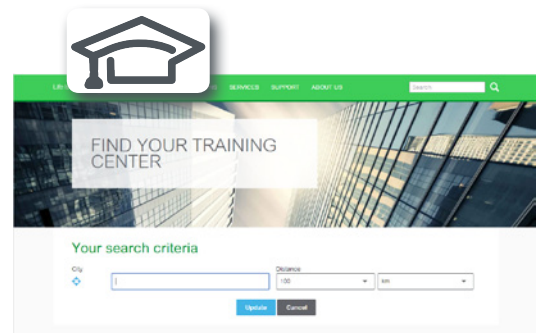

Life Is On



Contents

■ General presentation.....	page 2
<i>IP 21, IP 54, or IP 55 variable speed drive selection guide.....</i>	<i>page 4</i>
■ Altivar Process variable speed drives presentation.....	page 6
■ Altivar Process drive systems presentation.....	page 14
Altivar Process variable speed drives	
■ 200...240 V 50/60 Hz supply, IP 21/UL Type 1.....	page 16
■ 380...480 V 50/60 Hz supply.....	page 17
□ IP 21/UL Type 1, with integrated category C2 or C3 EMC filter.....	page 17
□ IP 55, with integrated category C2 or C3 EMC filter.....	page 18
□ IP 55, with Vario disconnect switch and integrated category C2 or C3 EMC filter.....	page 19
■ 380...440 V 50/60 Hz supply.....	page 20
□ IP 21, floor-standing, with integrated category C3 EMC filter.....	page 20
□ IP 54, floor-standing, with integrated category C3 EMC filter.....	page 20
■ Replacement parts.....	page 23
■ Graphic display terminal.....	page 24
■ Accessories.....	page 25
■ Web server.....	page 26
■ DTM libraries and SoMove setup software.....	page 27
Options	
■ Drive/option combinations.....	page 28
■ I/O expansion modules.....	page 32
■ Communication buses and networks.....	page 34
■ Passive filters.....	page 42
■ EMC filters.....	page 47
■ dv/dt filters.....	page 50
■ Sinus filters.....	page 52
■ Common mode filters.....	page 54
Motor starters	
■ 200...240 V 50/60 Hz supply.....	page 56
■ 380...415 V 50/60 Hz supply.....	page 57
■ 440 V 50/60 Hz supply.....	page 59
Dimensions	
■ Drives.....	page 62
■ Options.....	page 65
Services	
■ A whole world of services for your drives.....	page 70
Index	
■ Product reference index.....	page 72

Altivar Process

Provides the efficiency you deserve

Altivar Process drives offer extensive flexibility in water & wastewater, mining, minerals & metals, oil & gas and food & beverage applications. Depending on customer requirements, wall-mounting drives, built-in cabinet and floor-standing solutions are available with IP 21, IP 23, IP 54, and IP 55 protection.

Wall-mounting drives from 0.75 kW to 315 kW

Floor-standing drives from 110 kW to 315 kW

Drive systems from 110 kW to 800 kW



From basic design to customized offer

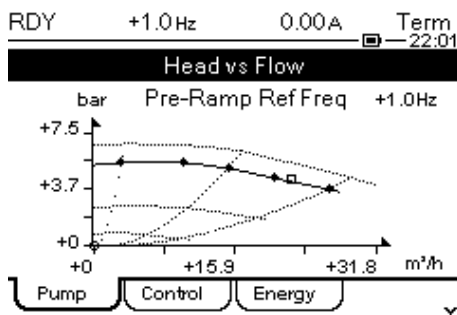

Display screen

Altivar Process drives

Business optimization

Optimum monitoring of your process

- > Instant reaction if pump efficiency drops thanks to the embedded pump monitoring
- > Notification of critical operating points without additional sensors
- > Process integration with pressure, flow, and level control including compensation of flow losses

The energy-saving drive solution

- > Up to 30% energy saving when on standby due to the innovative "Stop & Go" operation without additional costs
- > Smart control of the internal fans depending on operation
- > Optimum energy efficiency over the whole life cycle
- > Data logging and graphic display of the power consumption

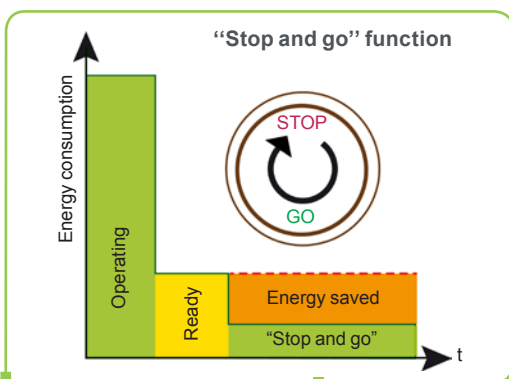

Real-time intelligence

Web server and services via Ethernet

- > Embedded Web server interface based on the Ethernet network gives you process monitoring with your daily working tools.
- > Local and remote access to energy use and customized dashboards means your energy is visible anywhere, any time, on PC, tablet, or smartphone.



ODVA organization:
supports network
technologies based on
EtherNet/IP



FDT Technology: an
international standard
with broad acceptance
in the automation
industry



Achilles™ Level2 certified



User-friendliness

Simple integration in PLC environments

- > Easy integration thanks to standardized FDT/DTM and ODVA technology
- > Supported by predefined Unity Pro libraries
- > Easy access via PC, tablet, or smartphone
- > Secure connection via “Cyber-secure Ethernet”

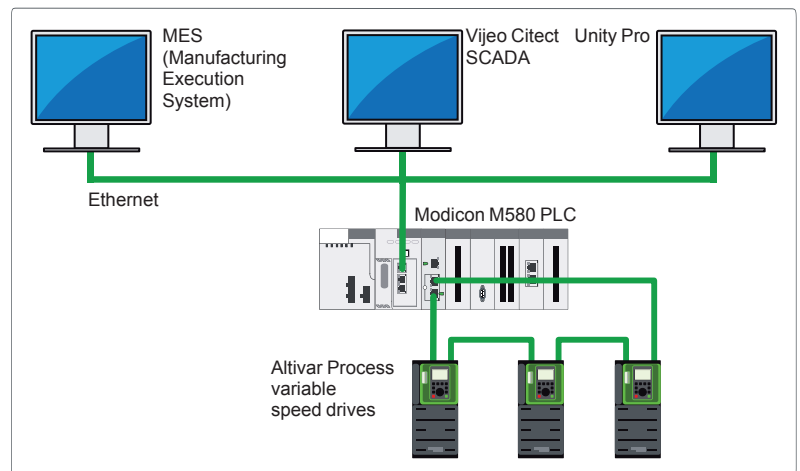

Integration in the Modicon M580 automation platform



Scanning the QR code from a smartphone or tablet

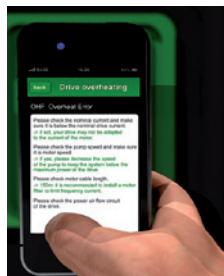

Instant access to online help

Sophisticated service concept

- > Modular design provides easy spare parts logistics
- > Optimized maintenance costs due to dynamic maintenance schedule, with integrated monitoring of individual components
- > Simple exchange of power modules and fans
- > Quick assistance with dynamic QR codes and Customer Care app



Green product

Designed to have a smaller carbon footprint

- > The Green Premium product label, Schneider Electric's eco-mark, indicates your compliance with international environmental standards such as:
 - > RoHS-2 according to EU directive C€ 2002/95
 - > REACH according to EU regulation 1907/2006
 - > IEC 62635: the end-of-life instructions comply with the latest recycling rules, 70% of the product components can be recycled.

IP 21, IP 55, or IP 54 variable speed drives for asynchronous and synchronous motors

Market segments

- Water & wastewater
- Oil & gas
- Mining, minerals & metals
- Food & beverage



Mounting type	Wall mounting
Degree of protection	IP 21/UL Type 1
Power range for 50...60 Hz line supply	Three-phase: 200...240 V (kW/HP)
	Three-phase: 380...440 V (kW)
	Three-phase: 380...480 V (kW/HP)
Drive	Output frequency
	Control type
Functions	Advanced functions
	Integrated safety function
Number of integrated I/O	Analog inputs
	Digital inputs
	Analog outputs
	Relay outputs
	Safety function inputs
I/O expansion modules (optional)	Analog inputs
	Digital inputs
	Digital outputs
Relay output module (optional)	Relay outputs
	Communication
Configuration and runtime tools	Integrated
	Option modules
Standards and certifications	UL 508C, EN/IEC 61800-3, EN/IEC 61800-3 environment 1 category C2, EN/IEC 61800-3 environment 2 category C3, EN/IEC 61800-5-1, IEC 61000-3-12, IEC 60721-3, IEC 61508, DNV-GL Marine certification, ATEX 2/22, ATEX 1/21
	EN/IEC 61800-3, EN/IEC 61800-3 environment 2 category C3, EN/IEC 61800-5-1, IEC 60721-3, IEC 61508, ATEX 2/22, ATEX 1/21
References	ATV630●●●●●
Page	16

Wall mounting	Floor standing
IP 21/UL Type 1	IP 21
0.75...75/1...100	–
–	110...315/150...500
0.75...315/1...500	–
0.1...500 Hz	–
Standard constant torque, variable standard torque, optimized torque mode	–
PM (permanent magnet) motor	–
<ul style="list-style-type: none"> ■ Accurate measurement for monitoring system energy consumption (deviation < 5%) ■ Installation energy drift detection ■ Embedded Ethernet with direct access to system configuration and monitoring ■ Integration of actual pump curves to optimize the system operating point ■ Optimized pump monitoring based on actual operating point ■ Sensorless estimated flow rate ■ Measurements expressed in working units (e.g.: m³/h, kWh/m³) ■ Limitation of overvoltage at the motor terminals ■ Contextual access to technical documentation through dynamic QR code ■ Continuous and historical real-time measurements with customizable dashboards ■ Predictive and preventive maintenance tracking functions (e.g.: temperatures with PT100/1000 probe, fan monitoring) 	–
1: STO (Safe Torque Off) SIL3	–
16	–
3: Configurable as voltage (0...10 V) or current (0-20 mA/4-20 mA), including 2 for probes (PTC, PT100, PT1000, or KTY84)	–
6	–
2: Configurable as voltage (0...10 V) or current (0-20 mA)	–
3	–
2: For safety function STO	–
2 differential analog inputs configurable via software as current (0-20 mA/ 4-20 mA), or for PTC, PT100, or PT1000, 2 or 3-wire	–
6: Voltage 24 V ⎓ (positive or negative logic)	–
2: Assignable	–
3: NO contacts	–
Modbus/TCP, Modbus serial link	–
EtherNet/IP and Modbus/TCP Dual port, ProfiNet, CANopen RJ45 Daisy Chain, Sub-D and screw terminals, Profibus DP V1, and DeviceNet	–
Graphic display terminal, embedded Web server, DTM (Device Type Manager), SoMove software	–
UL 508C, EN/IEC 61800-3, EN/IEC 61800-3 environment 1 category C2, EN/IEC 61800-3 environment 2 category C3, EN/IEC 61800-5-1, IEC 61000-3-12, IEC 60721-3, IEC 61508, DNV-GL Marine certification, ATEX 2/22, ATEX 1/21	EN/IEC 61800-3, EN/IEC 61800-3 environment 2 category C3, EN/IEC 61800-5-1, IEC 60721-3, IEC 61508, ATEX 2/22, ATEX 1/21
ATV630●●●●●	ATV630●●●●●F
16	18

- Water & wastewater
- Oil & gas
- Mining, minerals & metals
- Food & beverage



Wall mounting	Wall mounting	Floor standing
IP 55	IP 55 with Vario disconnect switch	IP 54
–	–	–
–	–	110...315/150...500
0.75...90/1...125	–	–
0.1...500 Hz	–	–
Standard constant torque, variable standard torque, optimized torque mode	–	–
PM (permanent magnet) motor	–	–
<ul style="list-style-type: none"> ■ Accurate measurement for monitoring system energy consumption (deviation < 5%) ■ Installation energy drift detection ■ Embedded Ethernet with direct access to system configuration and monitoring ■ Integration of actual pump curves to optimize the system operating point ■ Optimized pump monitoring based on actual operating point ■ Sensorless estimated flow rate ■ Measurements expressed in working units (e.g.: m³/h, kWh/m³) ■ Limitation of overvoltage at the motor terminals ■ Contextual access to technical documentation through dynamic QR code ■ Continuous and historical real-time measurements with customizable dashboards ■ Predictive and preventive maintenance tracking functions (e.g.: temperatures with PT100/1000 probe, fan monitoring) 	–	–
1: STO (Safe Torque Off) SIL3	–	–
16	–	–
3: Configurable as voltage (0...10 V) or current (0-20 mA/4-20 mA), including 2 for probes (PTC, PT100, PT1000, or KTY84)	–	–
6	–	–
2: Configurable as voltage (0...10 V) or current (0-20 mA)	–	–
3	–	–
2: For safety function STO	–	–
2 differential analog inputs configurable via software as current (0-20 mA/ 4-20 mA), or for PTC, PT100, or PT1000, 2 or 3-wire	–	–
6: Voltage 24 V ⎓ (positive or negative logic)	–	–
2: Assignable	–	–
3: NO contacts	–	–
Modbus/TCP, Modbus serial link	–	–
EtherNet/IP and Modbus/TCP Dual port, ProfiNet, CANopen Daisy Chain RJ45, Sub-D and screw terminals, Profibus DP V1, and DeviceNet	–	–
Graphic display terminal, embedded Web server, DTM (Device Type Manager), SoMove software	–	–
UL 508C, EN/IEC 61800-3, EN/IEC 61800-3 environment 1 category C2, EN/IEC 61800-3 environment 2 category C3, EN/IEC 61800-5-1, IEC 61000-3-12, IEC 60721-3, IEC 61508, DNV-GL Marine certification, ATEX 2/22, ATEX 1/21	EN/IEC 61800-3, EN/IEC 61800-3 environment 1 category C2, EN/IEC 61800-3 environment 2 category C3, EN/IEC 61800-5-1, IEC 61000-3-12, IEC 60721-3, IEC 61508, DNV-GL Marine certification, ATEX 2/22, ATEX 1/21	EN/IEC 61800-3, EN/IEC 61800-3 environment 2 category C3, EN/IEC 61800-5-1, IEC 60721-3, IEC 61508, ATEX 2/22, ATEX 1/21
ATV650●●●●●	ATV650●●●●●E	ATV650●●●●●F
19	20	21



Altivar Process range

Process

The Altivar Process drive is an IP 21, IP 54, or IP 55 frequency inverter for three-phase synchronous and asynchronous motors, specially designed for the following market segments:

- Water & wastewater
- Oil & gas
- Mining, minerals & metals
- Food & beverage



Water & wastewater applications

- Pumping
- Drilling
- Suction
- Dosing
- Odor control
- Ventilation
- Gas compression
- Sludge removal

Use

- Pumping station and storage tank
- Irrigation
- Treatment plant
- Desalination plant
- Storage and booster station
- Housing
- Wastewater lift station
- Wastewater treatment
- Discharge back into the environment, land application



Process (continued)

Oil & gas applications

- Hydrocarbon production:
 - Drilling
 - Offshore and onshore extraction
 - Water treatment and re-injection
 - Crude oil storage
 - Separation
 - Pipeline pumping
 - Storage
 - Refining
 - DOF (digital oil field)

Use

- Pumps:
 - Submersible
 - Hydraulic
 - Pipeline
 - Reverse flow
 - Water injection
 - Kerosene
- Regasification compressors
- Refining:
 - Fans
 - Compressors



Mining, minerals & metals applications

- Flotation and thickening
- Rinsing and filtration
- Mine shaft pumping
- Preheater fan
- Waste gas evacuation
- Cooling fan
- Separator for vertical roller mill
- Storage and loading
- Water supply
- Pumping
- Drying fans

Use

- Conveyors
- Grinders
- Mixers
- Pumps



Food & beverage applications

- Pumping
- Drying fans

Use

- Conveyors
- Mixers
- Centrifuges
- Pumps



10% (control)

90% (power)

Cooling system with two separate air flows

General presentation of the offer

Altivar Process drives can help improve equipment performance and reduce operating costs by optimizing energy consumption and user comfort.

Altivar Process drives provide a wide range of integrated functions, such as:

- Safety and automation functions that meet the requirements of some of the most demanding applications
- Various optional communication modules available for seamless integration into the main automation architectures
- Numerous configurable I/O as standard to facilitate adaptation to specific applications
- Intuitive commissioning using the graphic display terminal
- Local and remote access and monitoring using the embedded Web server
- Energy savings and protection of the grid by means of integrated harmonic filters
- Installation EMC conformity by means of integrated EMC filters
- Altivar Process drives are designed for IT systems

Depending on the power range, Altivar Process is available with several mounting types and protection indices:

- Wall-mounting IP 21/UL Type 1 from 0.75 to 315 kW/1 to 500 HP, ready-to-use for easy integration inside or without an enclosure in an electrical room
- Wall-mounting IP 55 from 0.75 to 90 kW/1 HP to 125 HP, ready-to-use for easy integration in a harsh environment or in an outdoor installation close to the system to reduce the length of the motor cable. The wall-mounting IP 55 offer is available with and without a disconnect switch.
- Floor-standing IP 21 and IP 54 from 110 to 315 kW, ready-to-use in high-power ranges with minimum dimensions for easy, optimized integration in an electrical room in a standard or harsh environment

Floor-standing high-power drives

The floor-standing IP 21/IP 54 drive offers integrate:

- Drive power and control modules
- Semiconductor protection fuses
- Line chokes to limit THDI levels
- A filter to help protect the motor against the effects of dv/dt
- Accessible busbars to simplify the motor wiring and power wiring

The IP 54 variant features additional equipment, such as:

- A main switch with external handle
- A system for separating the cooling air flow between the power and control parts, allowing operation in a highly polluted environment as well as optimum management of thermal stress in the plant room

Altivar Process drives can also be supplied as engineered drive system variants from 110 to 800 kW, developed by Schneider Electric based on customer specifications. Engineered drives are available as standard with THDI level < 48% and as a low harmonic solution with THDI level < 5%.

Rugged

Altivar Process drives are designed to adapt to the harshest environments.

- Ambient operating temperature
- Wall-mounting drives:
 - IP 21: up to 160 kW, -15...+50 °C/+ 5...122 °F as standard, up to 60 °C/140 °F with derating; above 160 kW, -10...+40 °C/+ 14...104 °F as standard, up to 60 °C/140 °F with derating (1)
 - IP 55: -15...+40 °C/5...104 °F as standard, up to 50 °C/122 °F with derating
- Floor-standing IP 21/IP 54 drives:
 - 0... 40 °C/32...104 °F as standard
 - 40...50 °C/104...122 °F with derating
- Storage and transport temperature: -40...+70 °C/-40...+158 °F
- Operating altitude:
 - 0...1,000 m/0...3,281 ft without derating
 - 1,000...4,800 m/3,281...15,748 ft with derating of 1% per 100 m/328 ft
- Withstand to harsh environments:
 - Chemical class 3C3 conforming to IEC/EN 60721 (2)
 - Mechanical class 3S3 conforming to IEC/EN 60721 (2)
 - Electronic cards with protective coating
- Protection to suit requirements:
 - IP 21/UL type 1 for wall mounting in a plant room and in an enclosure
 - IP 55 for wall mounting, with protection against dust and water jets
 - Floor-standing IP 21
 - Floor-standing IP 54, with protection against dust and water jets

(1) A patented flange mounting kit allows to remove the heat generated by the power unit outside the enclosure when the variable speed drive is integrated in a cabinet (see page 23).

(2) Altivar Process ATV630C22...C31N4 drives are certified as chemical class 3C2 and mechanical class 3S2 conforming to IEC/EN 60721.

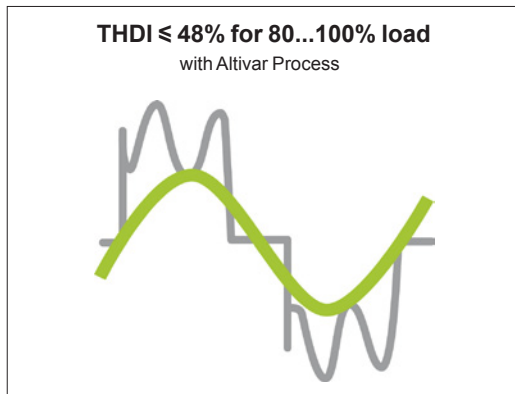

Altivar Process drive THDI

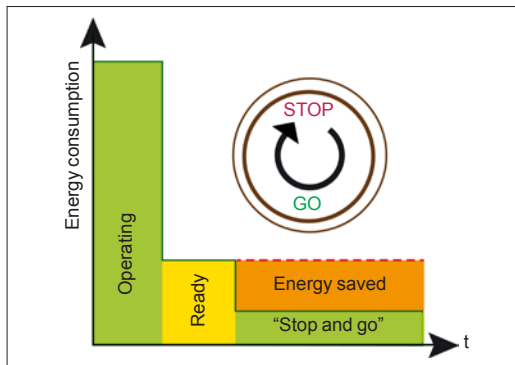

"Stop and go" function

General presentation of the offer (continued)

Energy

Altivar Process drives help to optimize power consumption by reducing the rms input current for the same load.

- Standard offer:
 - THDI $\leq 48\%$ for 80 to 100% load, which is used to maintain an optimum power factor on the most common operating range
- Low harmonic offer compatible with standard IEEE 519

In addition, thanks to the "stop and go" function, Altivar Process drives can reduce power consumption by up to 30% during system stop phases by disabling some functions automatically (the power section, fans, backlighting, etc). On a system restart request, the Altivar Process drive takes less than 2 seconds to restart the motor.

Integrated as standard, the "stop and go" function can be enabled and disabled in the drive parameters.

Environment

The Altivar Process drives offer has been developed to meet the requirements of directives regarding protection of the environment and to anticipate future changes in regulations:

- RoHS-2 (1)
- REACh (2) + Solution for REACh Substitute It Now (halogen-free wiring and plastics)
- PEP (Product Environmental Profile) eco-passport program for reducing the carbon footprint and conserving raw materials
- EoLI (End of Life Instruction) (3)
- More than 70% recyclable materials (new ruling)
- Efficient energy management: 30% reduction in consumption

Electromagnetic compatibility (EMC)

Compliance with electromagnetic compatibility requirements has been incorporated into the design of the drive, which simplifies installation and provides an economical means of helping to ensure equipment meets CE marking requirements. Altivar Process drives have a category C2 or C3 EMC filter, except ATV630U07M3...D75M3 models which can take an additional filter to meet more stringent requirements (see page 44).

Installation/Maintenance

Altivar Process drives are ergonomically designed to adapt to any type of installation:

- Products, systems, or integrated in iMCC
- IP 21, UL type 1; IP 55, IP 54
- Easy installation of products and systems:
 - Cable entry equipped with Romex cable clamps to maintain an EMC connection for the power and control cable
 - Color code for connections to the removable terminal blocks on the HMI block
 - Long cable: Up to 150 m with category C3 EMC filter
- Asynchronous or synchronous drive in open loop for 0.1...500 Hz output frequency
- Special motors: Submersible and tapered rotor motors
- Lower maintenance costs due to drive's ergonomic design:
 - Fans can be replaced in less than 5 minutes
 - No maintenance tool required
 - Limited number of parts
- Embedded Web server:
 - Compatible process elements for easier implementation
 - Direct worldwide access to monitoring and maintenance functions:
 - Reading values
 - Modifying data
 - Configuring parameters
 - Changing controller status

(1) European directive 2002/95/EC Restriction Of Hazardous Substances (applicable in 2016).

(2) European regulation 1907/2006.

(3) According to IEC 62635 Enhanced Guidelines.

Integrated functions

Altivar Process drives include numerous advanced functions for the more complex applications in each market segment.

Advanced functions

- Accurate measurement for monitoring system energy consumption (deviation < 5%)
- Installation energy drift detection
- Embedded Ethernet with direct access to system configuration and monitoring
- Integration of actual pump curves to optimize the system operating point
- Optimized pump monitoring based on actual operating point
- Sensorless estimated flow rate
- Measurements expressed in working units (e.g.: m³/h, kWh/m³)
- Limitation of overvoltage at the motor terminals
- Contextual access to technical documentation through dynamic QR code
- Continuous and historical real-time measurements with customizable dashboards
- Predictive and preventive maintenance tracking functions (e.g.: temperatures with PT100/1000 probe, fan monitoring)

Power measurement function

Altivar Process drives integrate a power measurement function accurate to within 5%, based on measurement of the motor voltage and the power supply:

- Process drift detection for installation reliability throughout its entire service life
- Useful system performance information provided by comparing the energy used with the energy produced:
- Typical KPIs:
 - Specific energy consumption
 - kWh/m³
 - kWh/mWc/m³

Users are therefore able to monitor and analyze input power, energy produced, and the KPIs directly from the drive or from the process management system.

Safety and monitoring functions

The Safety function STO and numerous monitoring functions are provided to help protect personnel and equipment.

- Advantages:
 - Time savings in terms of installation design and compliance
 - Fewer components and cables
 - Optimum space
 - Simplified setup of machines
 - Improved maintenance performance; limited machine intervention time and installation downtime
 - Optimized conditions for maintenance operations
- Conformity to standards EN/IEC 61508, EN/ISO 13849, IEC 61800-5-2
- Integrated STO (Safe Torque Off) function, SIL3/Plc
- Monitoring function to help protect against premature wear:
 - Monitoring of pumping cycles
 - Start-stop of centrifugal pumps
 - Monitoring of start cycles (number of starts per hour)
 - Monitoring function to help protect against water hammer
 - Cleaning of pumps by reversing the flow (anti-clogging)

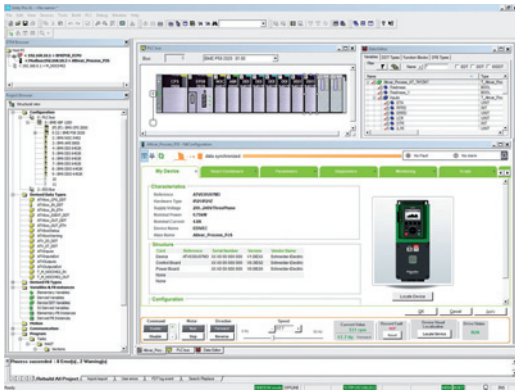

Altivar Process DTM in Unity Pro

Integration

Communication protocols

- Modbus/TCP, EtherNet/IP, and Modbus serial link:
 - Standard Modbus and Ethernet protocols
 - Connection of configuration and runtime tools
 - Control and supervision of the Altivar Process in process architectures (controllers, SCADA systems, HMIs, etc.) in industrial networks (read/write data)
 - Diagnostic, supervision, and fieldbus management functions
- Ethernet services:
 - SNMP, SNTP, BootP & DHCP, IP v6, cybersecurity services, FDR
 - Open Ethernet topologies

Integration of configuration and runtime tools

- FDT/DTM technology (see page 27):
 - Drive configuration, diagnostics, and control using Unity Pro software

Configuration and runtime tools

- Graphic display terminal (see page 24):
 - Drive control, adjustment, and configuration
 - Display of current values (motor, I/O, etc.)
 - Configuration storage and download
 - Duplication of one drive configuration on another drive from a PC or another drive
 - Remote use by means of appropriate accessories (see page 25)
 - Connection to several drives using multidrop link components (see page 25)
- Embedded Web server (see page 26):
 - Easily accessible from any PC, iPhone, iPad, Android system, and major web browsers
 - Network diagnostics in real time
 - Read/write values
- SoMove software (see page 27):
 - Advanced functions for configuration, setup, and maintenance of Altivar Process drives

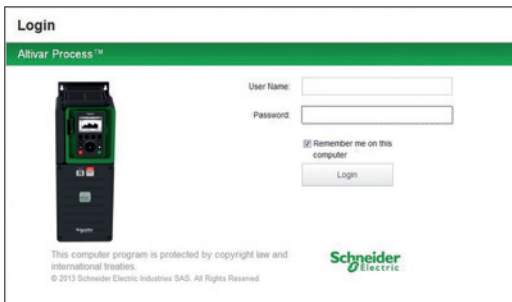

Embedded Web server login screen

Integrated services

Altivar Process drives feature integrated services to achieve optimum time savings:

- Simplified communication:
 - Ethernet port with embedded Web server
- Energy management (integrated power measurement)
- Dynamic predictive maintenance
- 3 QR codes:
 - 1: Access to the Customer Care Center application and product data sheet
 - 2: Direct access to description of the functions
 - 3: QR code generated in the event of a detected error (red screen): Identification of the detected error, probable causes, and remedies



ATV630...N4F, ATV630...M3, ATV650...N4, ATV650...N4E

Extensive offer

The Altivar Process offer covers motor power ratings from 0.75...315 kW/1...500 HP for three-phase voltages between 200...240 V and 380...480 V.

Three-phase power supply	Motor power	Degree of protection	Reference
200...240 V	0.75 kW...75 kW 1...100 HP	IP 21 UL type 1	ATV630U07M3...D75M3
380...480 V	0.75 kW...315 kW 1...500 HP	IP 21 UL type 1	ATV630U07N4...C31N4
		IP 55	ATV650U07N4...D90N4
		IP 55	ATV650U07N4E...D90N4E (1)
380...440 V	110 kW...315 kW 150...500 HP	IP 21	ATV630C11N4F...C31N4F
		IP 54	ATV650C11N4F...C31N4F

(1) Integrated with disconnect switch.

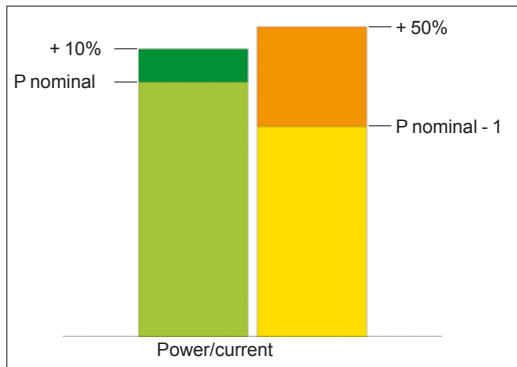

Normal duty and Heavy duty modes

Altivar Process variable speed drives are designed for use in two operating modes that can optimize the drive nominal rating according to the system constraints.

These two modes are:

- Normal duty (ND): Dedicated mode for applications requiring a slight overload (up to 110%) with a motor power no higher than the drive nominal power
- Heavy duty (HD): Dedicated mode for applications requiring a significant overload (up to 150%) with a motor power no higher than the drive nominal power derated by one rating

Accessories and options

Altivar Process drives are designed to take numerous accessories and options to increase their functionality and also their capacity for integration and adaptation.

Accessories

- Drive:
- Fan kit (see page 19)
- Graphic display terminal:
- Remote mounting kit for mounting on enclosure door (see page 25)
- Multidrop connection accessories for connecting several drives to the RJ45 terminal port (see page 25)

Options

- Modules (see page 32):
- I/O expansion:
 - 2 analog inputs
 - 6 digital inputs
 - 2 digital outputs
- With relay output:
 - 3 NO contacts
- Communication:
 - EtherNet/IP and Modbus TCP Dual port
 - CANopen bus: RJ45 daisy chain, SUB-D, 5-way screw terminals
 - PROFINET bus
 - Profibus DP V1 bus
 - DeviceNet bus
- Passive filters (see page 42)
- Additional EMC input filters for reducing conducted emissions on the line (see page 47)
- Output filters:
 - dv/dt filters (see page 50)
 - Sinus filters (see page 52)

Motor starters

Schneider Electric offers combinations of circuit breakers and contactors to be able to use Altivar Process drives in optimum conditions (see page 56).



Engineered drive system based on the ATV660C50Q4X1 drive

Engineered drive systems

Engineered drive systems from 0.75 to 800 kW based on the Altivar Process platform offer solutions ranging from compact enclosed systems to complex outdoor skids including third-party components or transformers, independent of the power range.

All engineered drive systems are fully tested and ready-to-connect drive solutions.

Several solutions are available depending on customer requirements.

Compact drive systems

Compact drive systems are enclosure units with a built-in variable speed drive to control the speed of asynchronous or synchronous motors. The modular construction makes it possible to adapt the enclosure unit to particular requirements.

Compact design

- Less space required in the control room
- Generous connection area for power cables
- Easy access to components
- Control panel for numerous options

The energy-saving drive solution

- Up to 60% energy savings without additional costs
- Intelligent control of internal fans, depending on the operation
- Optimal energy efficiency over the entire life cycle
- Logging and graphic presentation of absorbed power



Full ETO drive system

Low harmonic drive systems

This new technology reaches a total harmonic distortion (THD(i)) of ~ 2%, and fulfills the requirements of the IEEE 519 standard for THD(i) < 5% in the event of distorted AC supply.

Extended motor lifetime with 3-level concept

The 3-level technology of the active mains rectifier reduces the voltage load at the motor significantly, compared to other low harmonic variable speed drives. The fluctuating adaptation of the DC link voltage helps extend the motor lifetime.

Reduced losses with 3-level concept

In comparison with the traditional circuit structure of active mains rectifiers, the switching frequency is increased and the current load is reduced at the same time when using 3-level technology.

Compact dimensions thanks to 3-level concept

A significant advantage of the 3-level technology is the reduced dimensions of the integrated filter components. Due to the increased switching frequency and to its location inside the forced cooling air channel, the dimensions of the filter can be almost halved.

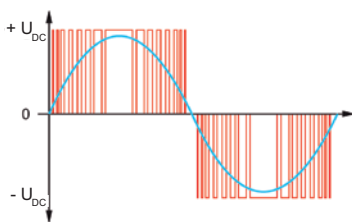

2-level technology

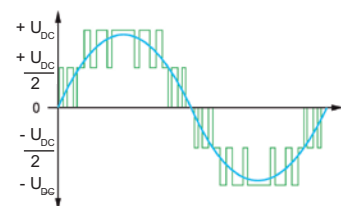

3-level technology



People

- Worldwide network, 24/7:
- 400 highly qualified and certified experts
- Field service engineers, online experts

Engineered Drive Systems (continued)

Superior services

Our industry experts help you get the maximum return from your investments and optimize the value of your installations throughout their life cycle. Whether you need a brief telephone consultation, an on-site analysis, or the development of an entire system solution, our experts are at your disposal.

Audits and consultancy services

- From the selection of drives and accessories to the development of entire system solutions
- On-site analysis
- Line supply consultancy (compensation, filtering, harmonics, etc.)

Bespoke project management

- Measurement and analysis of your site
- Target definition
- Identification of opportunities to save energy and reduce costs
- Calculation of return on investment

Customized training

- Our experienced specialists offer training, either at our premises or at your site

Commissioning and on-site services

- Our specialists, experienced in a wide range of industrial sectors, leverage their extensive product and application knowledge to commission your systems

Digital services

- On-screen and event-specific QR codes help operators diagnose detected errors quickly
- Online troubleshooting with step-by-step procedures
- Track and analyze events related to your drive
- Automatic creation of technical support requests

For further information, please consult your local Schneider Electric drives expert.

Variable speed drives

Altivar Process

Three-phase supply voltage: 200...240 V 50/60 Hz

Wall-mounting drives



ATV630D11M3



ATV630D15M3



ATV630D30M3



ATV630D75M3

200...240 V IP 21/UL Type 1 drives (1)										
Motor			Line supply				Altivar Process			
Power indicated on rating plate (2)			Line current (3)		Apparent power	Maximum prospective line Isc	Maximum continuous current (2)	Max. transient current for 60 s	Reference (1)	Weight
			200 V	240 V						
ND:	Normal duty (4)									
HD:	Heavy duty (5)									
	kW	HP	A	A	kVA	kA	A	A	kg/lb	
THDI ≤ 44% at 100% load in Normal duty (4)										
ND	0.75	1	3	2.6	1.1	50	4.6	5.1	ATV630U07M3	4.300/9.480
HD	0.37	0.5	1.7	1.5	0.6	50	3.3	5		
ND	1.5	2	5.9	5	2.1	50	8	8.8	ATV630U15M3	4.300/9.480
HD	0.75	1	3.3	3	1.2	50	4.6	6.9		
ND	2.2	3	8.4	7.2	3	50	11.2	12.3	ATV630U22M3	4.500/9.921
HD	1.5	2	6	5.3	2.2	50	8	12		
ND	3	–	11.5	9.9	4.1	50	13.7	15.1	ATV630U30M3	4.500/9.921
HD	2.2	3	8.7	7.6	3.2	50	11.2	16.8		
ND	4	5	15.1	12.9	5.4	50	18.7	20.6	ATV630U40M3	4.600/10.141
HD	3	–	11.7	10.2	4.2	50	13.7	20.6		
ND	5.5	7.5	20.2	17.1	7.1	50	25.4	27.9	ATV630U55M3	7.700/16.976
HD	4	5	15.1	13	5.4	50	18.7	28.1		
ND	7.5	10	27.1	22.8	9.5	50	32.7	36	ATV630U75M3	13.800/30.424
HD	5.5	7.5	20.2	17.1	7.1	50	25.4	38.1		
ND	11	15	39.3	32.9	13.7	50	46.8	51.5	ATV630D11M3	13.800/30.424
HD	7.5	10	27.2	23.1	9.6	50	32.7	49.1		
ND	15	20	52.6	45.5	18.9	50	63.4	69.7	ATV630D15M3	27.300/60.186
HD	11	15	40.1	34.3	14.3	50	46.8	70.2		
ND	18.5	25	66.7	54.5	22.7	50	78.4	86.2	ATV630D18M3	27.300/60.186
HD	15	20	53.1	44.9	18.7	50	63.4	95.1		
ND	22	30	76.0	64.3	26.7	50	92.6	101.9	ATV630D22M3	27.300/60.186
HD	18.5	25	64.8	54.5	22.7	50	78.4	117.6		
ND	30	40	104.7	88.6	36.8	50	123	135.3	ATV630D30M3	56.600/124.781
HD	22	30	78.3	67.1	27.9	50	92.6	138.9		
ND	37	50	128.0	107.8	44.8	50	149	163.9	ATV630D37M3	56.600/124.781
HD	30	40	104.7	88.6	36.8	50	123	184.5		
ND	45	60	155.1	130.4	54.2	50	176	193.6	ATV630D45M3	56.600/124.781
HD	37	50	128.5	108.5	45.1	50	149	223.5		
ND	55	75	189	161	61.1	50	211	232.1	ATV630D55M3 (6)	84.000/185.188
HD	45	60	156	134	50	50	176	264		
ND	75	100	256	215	83.7	50	282	310.2	ATV630D75M3 (6)	84.000/185.188
HD	55	75	189	161	61.1	50	211	316.5		

(1) Altivar Process ATV630U07M3...D75M3 drives have been designed without an EMC filter. An additional filter can be added to help meet more stringent requirements and reduce electromagnetic emissions.

(2) These values are given for a nominal switching frequency of 4 kHz up to ATV630D22M3 or 2.5 kHz for ATV630D30M3...D75M3, for use in continuous operation.

The switching frequency is adjustable from 2...12 kHz for all ratings.

Above 2.5 or 4 kHz (depending on the rating), the drive will automatically reduce the switching frequency in the event of an excessive temperature rise. For continuous operation above the nominal switching frequency, derate the nominal drive current (see the derating curves on our website www.schneider-electric.com).

(3) Typical value for the indicated motor power and for the maximum prospective line Isc.

(4) Values given for applications requiring a slight overload (up to 110%).

(5) Values given for applications requiring a significant overload (up to 150%).

(6) Product supplied as IP 00 for mounting in an enclosure. For IP 21 wall mounting, order the IP 21/UL Type 1 conformity kit VW3A9704 separately.

Note: Consult the summary tables of possible drive, option, and accessory combinations (see page 28).

Variable speed drives

Altivar Process

Three-phase supply voltage: 380...480 V 50/60 Hz

Wall Mounting Drives



ATV630D15N4



ATV630D30N4

380...480 V IP 21/UL Type 1 drives										
Motor		Line supply					Altivar Process		Reference	Weight
Power indicated on rating plate (1)		Line current (2)		Apparent power	Maximum prospective line Isc	Max. continuous current (1)	Max. transient current for 60 s			
kW	HP	380 V	480 V	380 V				kA	A	A
		A	A	kVA	kg/lb					
With category C2 integrated EMC filter										
ND	0.75	1	1.5	1.3	1.1	50	2.2	2.4	ATV630U07N4	4.500/9.921
HD	0.37	0.5	0.9	0.8	0.7	50	1.5	2.3		
ND	1.5	2	3	2.6	2.2	50	4	4.4	ATV630U15N4	4.500/9.921
HD	0.75	1	1.7	1.5	1.2	50	2.2	3.3		
ND	2.2	3	4.3	3.8	3.2	50	5.6	6.2	ATV630U22N4	4.500/9.921
HD	1.5	2	3.1	2.9	2.4	50	4	6		
ND	3	–	5.8	5.1	4.2	50	7.2	7.9	ATV630U30N4	4.600/10.141
HD	2.2	3	4.5	4	3.3	50	5.6	8.4		
ND	4	5	7.6	6.7	5.6	50	9.3	10.2	ATV630U40N4	4.600/10.141
HD	3	–	6	5.4	4.5	50	7.2	10.8		
ND	5.5	7.5	10.4	9.1	7.6	50	12.7	14	ATV630U55N4	4.700/10.362
HD	4	5	8	7.2	6.0	50	9.3	14		
ND	7.5	10	13.8	11.9	9.9	50	16.5	18.2	ATV630U75N4	7.700/16.976
HD	5.5	7.5	10.5	9.2	7.6	50	12.7	19.1		
ND	11	15	19.8	17	14.1	50	23.5	25.9	ATV630D11N4	7.700/16.976
HD	7.5	10	14.1	12.5	10.4	50	16.5	24.8		
ND	15	20	27	23.3	19.4	50	31.7	34.9	ATV630D15N4	13.600/29.983
HD	11	15	20.6	18.1	15.0	50	23.5	35.3		
ND	18.5	25	33.4	28.9	24	50	39.2	43.1	ATV630D18N4	14.200/31.306
HD	15	20	27.7	24.4	20.3	50	31.7	47.6		
ND	22	30	39.6	34.4	28.6	50	46.3	50.9	ATV630D22N4	14.300/31.526
HD	18.5	25	34.1	29.9	24.9	50	39.2	58.8		
ND	30	40	53.3	45.9	38.2	50	61.5	67.7	ATV630D30N4	28.000/61.729
HD	22	30	40.5	35.8	29.8	50	46.3	69.5		
ND	37	50	66.2	57.3	47.6	50	74.5	82	ATV630D37N4	28.200/62.170
HD	30	40	54.8	48.3	40.2	50	61.5	92.3		
ND	45	60	79.8	69.1	57.4	50	88	96.8	ATV630D45N4	28.700/63.273
HD	37	50	67.1	59.0	49.1	50	74.5	111.8		

(1) These values are given for use in continuous operation with a nominal switching frequency of 4 kHz (ATV630U07N4...D45N4).

The switching frequency is adjustable from 2...12 kHz (ATV630U07N4...D45N4).

Above the nominal switching frequency, the drive will automatically reduce it in the event of an excessive temperature rise.

For continuous operation above the nominal switching frequency, nominal drive current should be derated according to the derating curves available on www.schneider-electric.com.

(2) Typical value for the indicated motor power and for the maximum prospective line Isc.

(3) Values given for applications requiring a slight overload (up to 110%).

(4) Values given for applications requiring a significant overload (up to 150%).

Note: Consult the summary tables of possible drive, option, and accessory combinations (see page 28).

Variable speed drives

Altivar Process

Three-phase supply voltage: 380...480 V 50/60 Hz

Wall-mounting drives



ATV630D55N4



ATV630C25N4

380...480 V IP 21/UL Type 1 drives										
Motor			Line supply				Altivar Process			
Power indicated on rating plate (1)			Line current (2)		Apparent power	Maximum prospective line Isc	Max. continuous current (1)	Max. transient current for 60 s	Reference	Weight
			380 V	480 V	380 V					
ND:	Normal duty (3)									
HD:	Heavy duty (4)									
	kW	HP	A	A	kVA	kA	A	A		kg/lb
With category C3 integrated EMC filter										
ND	55	75	97.2	84.2	70	50	106	116.6	ATV630D55N4	56.500/124.561
HD	45	60	81.4	71.8	59.7	50	88	132		
ND	75	100	131.3	112.7	93.7	50	145	159.5	ATV630D75N4	58.000/127.868
HD	55	75	98.9	86.9	72.2	50	106	159		
ND	90	125	156.2	135.8	112.9	50	173	190.3	ATV630D90N4	58.500/128.970
HD	75	100	134.3	118.1	98.2	50	145	217.5		
ND	110	150	201	165	121.8	50	211	232.1	ATV630C11N4 (5)	82.000/180.779
HD	90	125	170	143	102.6	50	173	259.5		
ND	132	200	237	213	161.4	50	250	275	ATV630C13N4 (5)	82.000/180.779
HD	110	150	201	165	121.8	50	211	317		
ND	160	250	284	262	201.3	50	302	332.2	ATV630C16N4 (5)	82.000/180.779
HD	132	200	237	213	161.4	50	250	375		
ND	220	350	397	324	247	50	427	470	ATV630C22N4 (5)	172.000/379.195
HD	160	250	296	246	187	50	314	453		
ND	250	400	451	366	279	50	481	529	ATV630C25N4 (5)	203.000/447.538
HD	220	350	365	301	229	50	393	581		
ND	315	500	569	461	351	50	616	678	ATV630C31N4 (5)	203.000/447.538
HD	250	400	457	375	286	50	481	722		

- (1) These values are given for use in continuous operation with a nominal switching frequency of 2.5 kHz (ATV630D55N4...C31N4).
The switching frequency is adjustable from 2...8 kHz (ATV630D55N4...C31N4).
Above the nominal switching frequency, the drive will automatically reduce it in the event of an excessive temperature rise.
For continuous operation above the nominal switching frequency, nominal drive current should be derated according to the derating curves available on www.schneider-electric.com.
- (2) Typical value for the indicated motor power and for the maximum prospective line Isc.
- (3) Values given for applications requiring a slight overload (up to 110%).
- (4) Values given for applications requiring a significant overload (up to 150%).
- (5) Product supplied as IP 00 for mounting in an enclosure. For IP 21/UL Type1 wall mounting, an adaptation kit should be ordered separately (see page 28).

Note: Consult the summary tables of possible drive, option, and accessory combinations (see page 28).

Variable speed drives

Altivar Process

Three-phase supply voltage: 380...480 V 50/60 Hz

Wall-mounting drives



ATV650D15N4



ATV650D30N4



ATV650D55N4

380...480 V IP 55 drives with category C2 or C3 integrated EMC filter ⁽¹⁾										
Motor		Line supply				Altivar Process				
Power indicated on rating plate ⁽²⁾		Line current ⁽³⁾		Apparent power	Maximum prospective line Isc	Maximum continuous current ⁽²⁾	Max. transient current for 60 s	Reference ⁽⁶⁾	Weight	
		380 V	480 V	380 V						
ND:	Normal duty ⁽⁴⁾									
HD:	Heavy duty ⁽⁵⁾									
	kW	HP	A	A	kVA	kA	A	A		kg/lb
THDI ≤ 44% at 100% load in Normal duty ⁽⁴⁾										
ND	0.75	1	1.5	1.3	1.1	50	2.2	2.4	ATV650U07N4	10.500/ 23.149
HD	0.37	0.5	0.9	0.8	0.7	50	1.5	2.3		
ND	1.5	2	3	2.6	2.2	50	4	4.4	ATV650U15N4	10.500/ 23.149
HD	0.75	1	1.7	1.5	1.2	50	2.2	3.3		
ND	2.2	3	4.3	3.8	3.2	50	5.6	6.2	ATV650U22N4	10.500/ 23.149
HD	1.5	2	3.1	2.9	2.4	50	4	6		
ND	3	–	5.8	5.1	4.2	50	7.2	7.9	ATV650U30N4	10.600/ 23.369
HD	2.2	3	4.5	4	3.3	50	5.6	8.4		
ND	4	5	7.6	6.7	5.6	50	9.3	10.2	ATV650U40N4	10.600/ 23.369
HD	3	–	6	5.4	4.5	50	7.2	10.8		
ND	5.5	7.5	10.4	9.1	7.6	50	12.7	14	ATV650U55N4	10.700/ 23.589
HD	4	5	8	7.2	6.0	50	9.3	14		
ND	7.5	10	13.8	11.9	9.9	50	16.5	18.2	ATV650U75N4	13.700/ 30.203
HD	5.5	7.5	10.5	9.2	7.6	50	12.7	19.1		
ND	11	15	19.8	17	14.1	50	23.5	25.9	ATV650D11N4	13.700/ 30.203
HD	7.5	10	14.1	12.5	10.4	50	16.5	24.8		
ND	15	20	27	23.3	19.4	50	31.7	34.9	ATV650D15N4	19.600/ 43.211
HD	11	15	20.6	18.1	15	50	23.5	35.3		
ND	18.5	25	33.4	28.9	24	50	39.2	43.1	ATV650D18N4	20.600/ 45.415
HD	15	20	27.7	24.4	20.3	50	31.7	47.6		
ND	22	30	39.6	34.4	28.6	50	46.3	50.9	ATV650D22N4	20.600/ 45.415
HD	18.5	25	34.1	29.9	24.9	50	39.2	58.8		
ND	30	40	53.3	45.9	38.2	50	61.5	67.7	ATV650D30N4	50.000/ 110.231
HD	22	30	40.5	35.8	29.8	50	46.3	69.5		
ND	37	50	66.2	57.3	47.6	50	74.5	82	ATV650D37N4	50.000/ 110.231
HD	30	40	54.8	48.3	40.2	50	61.5	92.3		
ND	45	60	79.8	69.1	57.4	50	88	96.8	ATV650D45N4	50.000/ 110.231
HD	37	50	67.1	59	49.1	50	74.5	111.8		
ND	55	75	97.2	84.2	70	50	106	116.6	ATV650D55N4	87.000/ 191.802
HD	45	60	81.4	71.8	59.7	50	88	132		
ND	75	100	131.3	112.7	93.7	50	145	159.5	ATV650D75N4	87.000/ 191.802
HD	55	75	98.9	86.9	72.2	50	106	159		
ND	90	125	156.2	135.8	112.9	50	173	190.3	ATV650D90N4	87.000/ 191.802
HD	75	100	134.3	118.1	98.2	50	145	217.5		

(1) Category C2 EMC filter for ATV650U07N4...D45N4. Category C3 EMC filter above ATV650D45N4.

(2) These values are given for a nominal switching frequency of 4 kHz adjustable from 2...12 kHz up to ATV650D45N4 or 2.5 kHz adjustable from 2...8 kHz for ATV650D55N4...D90N4, for use in continuous operation.

Above 2.5 or 4 kHz (depending on the rating), the drive will automatically reduce the switching frequency in the event of an excessive temperature rise. For continuous operation above the nominal switching frequency, derate the nominal drive current (see the derating curves on our website www.schneider-electric.com).

(3) Typical value for the indicated motor power and for the maximum prospective line Isc.

(4) Values given for applications requiring a slight overload (up to 110%).

(5) Values given for applications requiring a significant overload (up to 150%).

(6) Supplied with cable gland.

Note: Consult the summary tables of possible drive, option and accessory combinations (see page 28).

Variable speed drives

Altivar Process

Three-phase supply voltage: 380...480 V 50/60 Hz

Wall-mounting drives



ATV650D15N4E



ATV650D30N4E



ATV650D55N4E

380...480 V IP 55 drives with Vario disconnect switch and category C2 or C3 integrated EMC filter (1)										
Motor			Line supply				Altivar Process			
Power indicated on rating plate (2)			Line current (3)		Apparent power	Maximum prospective line Isc	Maximum continuous current (2)	Max. transient current for 60 s	Reference (6)	Weight
			380 V	480 V	380 V					
ND:	Normal duty (4)									
HD:	Heavy duty (5)									
	kW	HP	A	A	kVA	kA	A	A		kg/lb
THDI ≤ 44% at 100% load in Normal duty (4)										
ND	0.75	1	1.5	1.3	1.1	50	2.2	2.4	ATV650U07N4E	10.500/23.149
HD	0.37	0.5	0.9	0.8	0.7	50	1.5	2.3		
ND	1.5	2	3	2.6	2.2	50	4	4.4	ATV650U15N4E	10.500/23.149
HD	0.75	1	1.7	1.5	1.2	50	2.2	3.3		
ND	2.2	3	4.3	3.8	3.2	50	5.6	6.2	ATV650U22N4E	10.500/23.149
HD	1.5	2	3.1	2.9	2.4	50	4	6		
ND	3	–	5.8	5.1	4.2	50	7.2	7.9	ATV650U30N4E	10.600/23.369
HD	2.2	3	4.5	4	3.3	50	5.6	8.4		
ND	4	5	7.6	6.7	5.6	50	9.3	10.2	ATV650U40N4E	10.600/23.369
HD	3	–	6	5.4	4.5	50	7.2	10.8		
ND	5.5	7.5	10.4	9.1	7.6	50	12.7	14	ATV650U55N4E	10.700/23.589
HD	4	5	8	7.2	6.0	50	9.3	14		
ND	7.5	10	13.8	11.9	9.9	50	16.5	18.2	ATV650U75N4E	13.700/30.203
HD	5.5	7.5	10.5	9.2	7.6	50	12.7	19.1		
ND	11	15	19.8	17	14.1	50	23.5	25.9	ATV650D11N4E	13.700/30.203
HD	7.5	10	14.1	12.5	10.4	50	16.5	24.8		
ND	15	20	27	23.3	19.4	50	31.7	34.9	ATV650D15N4E	19.600/43.211
HD	11	15	20.6	18.1	15	50	23.5	35.3		
ND	18.5	25	33.4	28.9	24	50	39.2	43.1	ATV650D18N4E	20.600/45.415
HD	15	20	27.7	24.4	20.3	50	31.7	47.6		
ND	22	30	39.6	34.4	28.6	50	46.3	50.9	ATV650D22N4E	20.600/45.415
HD	18.5	25	34.1	29.9	24.9	50	39.2	58.8		
ND	30	40	53.3	45.9	38.2	50	61.5	67.7	ATV650D30N4E	50.000/110.231
HD	22	30	40.5	35.8	29.8	50	46.3	69.5		
ND	37	50	66.2	57.3	47.6	50	74.5	82	ATV650D37N4E	50.000/110.231
HD	30	40	54.8	48.3	40.2	50	61.5	92.3		
ND	45	60	79.8	69.1	57.4	50	88	96.8	ATV650D45N4E	50.000/110.231
HD	37	50	67.1	59	49.1	50	74.5	111.8		
ND	55	75	97.2	84.2	70	50	106	116.6	ATV650D55N4E	87.000/191.802
HD	45	60	81.4	71.8	59.7	50	88	132		
ND	75	100	131.3	112.7	93.7	50	145	159.5	ATV650D75N4E	87.000/191.802
HD	55	75	98.9	86.9	72.2	50	106	159		
ND	90	125	156.2	135.8	112.9	50	173	190.3	ATV650D90N4E	87.000/191.802
HD	75	100	134.3	118.1	98.2	50	145	217.5		

(1) Category C2 EMC filter for **ATV650U07N4E...D45N4E**. Category C3 EMC filter above **ATV650D45N4E**.
 (2) These values are given for a nominal switching frequency of 4 kHz adjustable from 2...12 kHz up to **ATV650D45N4E** or 2.5 kHz adjustable from 2...8 kHz for **ATV650D55N4E...D90N4E**, for use in continuous operation.
 Above 2.5 or 4 kHz (depending on the rating), the drive will automatically reduce the switching frequency in the event of an excessive temperature rise. For continuous operation above the nominal switching frequency, derate the nominal drive current (see the derating curves on our website www.schneider-electric.com).
 (3) Typical value for the indicated motor power and for the maximum prospective line Isc.
 (4) Values given for applications requiring a slight overload (up to 110%).
 (5) Values given for applications requiring a significant overload (up to 150%).
 (6) Supplied with cable gland.

Note: Consult the summary tables of possible drive, option, and accessory combinations (see page 28).

Variable speed drives

Altivar Process

Three-phase supply voltage: 380...440 V 50/60 Hz,
Floor-standing drives

ATV630C16N4F

380...440 V IP 21 drives with category C3 integrated EMC filter ⁽⁵⁾										
Motor		Line supply				Altivar Process				
Power indicated on rating plate ⁽¹⁾		Line current ⁽²⁾		Apparent power	Maximum prospective line Isc	Maximum continuous current ⁽¹⁾	Max. transient current for 60 s	Reference	Weight	
		380 V	400 V	380 V						
ND:	Normal duty ⁽³⁾									
HD:	Heavy duty ⁽⁴⁾									
	kW	HP	A	A	kVA	kA	A	A	kg/lb	
THDI ≤ 44% at 100% load in Normal duty ⁽³⁾										
ND	110	–	207	195	135	50	211	232	ATV630C11N4F	300.000/ 661.386
HD	90	–	174	164	113	50	173	259		
ND	132	–	250	232	161	50	250	275	ATV630C13N4F	300.000/ 661.386
HD	110	–	207	197	136	50	211	316		
ND	160	–	291	277	192	50	302	332	ATV630C16N4F	300.000/ 661.386
HD	132	–	244	232	161	50	250	375		
ND	200	–	369	349	242	50	370	407	ATV630C20N4F	400.000/ 881.848
HD	160	–	302	286	198	50	302	453		
ND	250	–	453	432	299	50	477	524	ATV630C25N4F	400.000/ 881.848
HD	200	–	369	353	244	50	370	555		
ND	315	–	566	538	373	50	590	649	ATV630C31N4F	400.000/ 881.848
HD	250	–	453	432	299	50	477	715		

(1) These values are given for a nominal switching frequency of 2.5 kHz for use in continuous operation.

The switching frequency is adjustable from 2...8 kHz for all ratings.

Above 2.5 kHz, the drive will automatically reduce the switching frequency in the event of an excessive temperature rise. For continuous operation above the nominal switching frequency, derate the nominal drive current (see the derating curves on our website www.schneider-electric.com).

(2) Typical value for the indicated motor power and for the maximum prospective line Isc.

(3) Values given for applications requiring a slight overload (up to 110%).

(4) Values given for applications requiring a significant overload (up to 150%).

(5) Integrated motor chokes allowing a shielded motor cable length up to 300 m/984 ft in category C3 and an unshielded cable length up to 450 m/1,476 ft in category C4.

Note: Consult the summary tables of possible drive, option, and accessory combinations (see page 28).

Variable speed drives

Altivar Process

Three-phase supply voltage: 380...440 V 50/60 Hz,
Floor-standing drives



ATV650C31N4F

380...440 V IP 54 drives with switch and category C3 integrated EMC filter ⁽⁵⁾										
Motor		Line supply				Altivar Process				
Power indicated on rating plate ⁽¹⁾		Line current ⁽²⁾		Apparent power	Maximum prospective line Isc	Maximum continuous current ⁽¹⁾	Max. transient current for 60 s	Reference	Weight	
		380 V	400 V							380 V
ND:	Normal duty ⁽³⁾									
HD:	Heavy duty ⁽⁴⁾									
		kW	HP	A	A	kVA	kA	A	A	kg/lb
THDI ≤ 44% at 100% load in Normal duty ⁽³⁾										
ND	110	–	207	195	135	50	211	232	ATV650C11N4F	310.000/ 683.433
HD	90	–	174	164	113	50	173	259		
ND	132	–	250	232	161	50	250	275	ATV650C13N4F	310.000/ 683.433
HD	110	–	207	197	136	50	211	316		
ND	160	–	291	277	192	50	302	332	ATV650C16N4F	310.000/ 683.433
HD	132	–	244	232	161	50	250	375		
ND	200	–	369	349	242	50	370	407	ATV650C20N4F	420.000/ 925.941
HD	160	–	302	286	198	50	302	453		
ND	250	–	453	432	299	50	477	524	ATV650C25N4F	420.000/ 925.941
HD	200	–	369	353	244	50	370	555		
ND	315	–	566	538	373	50	590	649	ATV650C31N4F	420.000/ 925.941
HD	250	–	453	432	299	50	477	715		

(1) These values are given for a nominal switching frequency of 2.5 kHz for use in continuous operation.

The switching frequency is adjustable from 2...8 kHz for all ratings.

Above 2.5 kHz, the drive will automatically reduce the switching frequency in the event of an excessive temperature rise. For continuous operation above the nominal switching frequency, derate the nominal drive current (see the derating curves on our website www.schneider-electric.com).

(2) Typical value for the indicated motor power and for the maximum prospective line Isc.

(3) Values given for applications requiring a slight overload (up to 110%).

(4) Values given for applications requiring a significant overload (up to 150%).

(5) Integrated motor chokes allowing a shielded motor cable length up to 300 m/984 ft in category C3 and an unshielded cable length up to 450 m/1,476 ft in category C4.

Note: Consult the summary tables of possible drive, option, and accessory combinations (see page 28).

Replacement parts			
Description	For drive	Reference	Weight kg/ lb
Fan kit for IP 21 drives			
Fan, bracket, instruction sheets	ATV630U07M3...U40M3, ATV630U07N4...U55N4	VX5VPS1001	—
	ATV630U55M3, ATV630U75N4...D11N4	VX5VPS2001	—
	ATV630U75M3...D11M3, ATV630D15N4...D22N4	VX5VPS3001	—
	ATV630D15M3...D22M3, ATV630D30N4...D45N4	VX5VPS4001	—
	ATV630D30M3...D45M3, ATV630D55N4...D90N4	VX5VPS5001	—
	ATV630D55M3...D75M3, ATV630C11N4...C16N4	VX5VPS6001	—
	ATV630C11N4F...C31N4F	VX5VPM001 (5)	—
	ATV630C11N4F...C31N4F	VX5VPM002 (6)	—
	ATV630C22N4...C31N4	VZ3V1212 (8)	—
		VZ3V1213 (9)	—
Fan kit for IP 55 drives			
Fan, bracket, instruction sheets	ATV650U07N4...D22N4, ATV650U07N4E...D22N4E	VX5VP50A001	—
	ATV650D30N4...D90N4, ATV650D30N4E...D90N4E	VX5VP50BC001	—
Fan kit for IP 54 drives			
Fan, bracket, instruction sheets	ATV650C11N4F...C31N4F	VX5VPM001 (5)	—
	ATV650C11N4F...C31N4F	VX5VPM002 (6)	—
Fan filter for floor-standing drives			
Fan filter for floor-standing drives	ATV630C11N4F...C16N4F	NSYCAF223	—
	ATV650C11N4F...C16N4F		—
	ATV630C20N4F...C31N4F	NSYCAF291	—
	ATV650C20N4F...C31N4F		—
Accessories			
Description	For drive	Reference	Weight kg/ lb
Flange-mounting kit for separate air flow (7)	ATV630U07M3...U40M3, ATV630U07N4...U55N4	NSYPTDS1	—
	ATV630U55M3, ATV630U75N4...D11N4	NSYPTDS2	—
	ATV630U75M3...D11M3, ATV630D15N4...D22N4	NSYPTDS3	—
	ATV630D15M3...D22M3, ATV630D30N4...D45N4	NSYPTDS4	—
	ATV630D30M3...D45M3, ATV630D55N4...D90N4	NSYPTDS5	—
Wall-mounting kit	ATV630U07M3...D11M3, ATV630U07N4...D22N4	NSYAEFPFPTD	—
IP 21/UL Type 1 conformity kit	ATV630D55M3...D75M3, ATV630C11N4...C16N4	VW3A9704	—
UL Type 1 conformity kit	ATV630C22N4...C31N4	VW3A9212	—
		VW3A9213 (10)	—
IP 21 conformity kit	ATV630C22N4...C31N4	VW3A9112	—
		VW3A9113 (10)	—

(1) Integrated motor chokes allowing a shielded motor cable length up to 300 m/984 ft in category C3 and an unshielded cable length up to 450 m/1,476 ft in category C4.

(2) Typical value for the indicated motor power and for the maximum prospective line I_{sc} .

(3) Values given for applications requiring a slight overload (up to 110%).

(4) Values given for applications requiring a significant overload (up to 150%).

(5) VX5VPM001: power fan for IP 21 and IP 54 floor-standing drives (1 unit for ATV6●OC11N4F...C16N4F, 2 units for ATV6●OC20N4F...C31N4F).

(6) VX5VPM002: door fan for IP 21 and IP 54 floor-standing drives.

(7) RUE-2192 patented system.

(8) Fan power electronic for drive, with 1 unit for ATV630C22N4, 2 units for ATV630C25N4, and 3 units for ATV630C31N4.

(9) Internal fan for drive, with 1 unit for ATV630C22N4, 2 units for ATV630C25N4, and 3 units for ATV630C31N4.

(10) For drive without braking resistor.

Note: Consult the summary tables of possible drive, option, and accessory combinations (see page 28).



Graphic display terminal (example shows dynamic pump operation in relation to its optimum operation)



Detected fault: The screen's red backlight is activated automatically



Embedded dynamic QR codes for contextual, instantaneous access to online help



Scanning the QR code from a smartphone or tablet

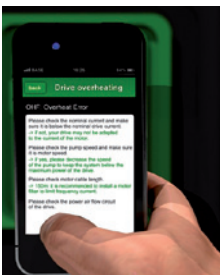

Instant access to online help

Graphic display terminal (supplied with the drive)

This terminal can be:

- Connected and mounted on the front of the drive
- Connected and mounted on an enclosure door using a remote mounting accessory
- Connected to a PC to exchange files via a Mini USB/USB connection (1)
- Connected to several drives in multidrop mode (see page 25)

This terminal is used to:

- Control, adjust, and configure the drive
- Display current values (motor, I/O, and process data)
- Display graphic dashboards such as the energy consumption monitoring dashboard
- Store and download configurations (several configuration files can be stored in the 16 MB memory)
- Duplicate the configuration of one powered-up drive on another powered-up drive
- Copy configurations from a PC or drive and duplicate them on another drive (the drives must be powered on for the duration of the duplication operations)

Other characteristics:

- Up to 24 languages (complete alphabets) covering the majority of countries around the world (languages can be removed, added, and updated according to user requirements; please consult our website www.schneider-electric.com)
- 2-color backlit display (white and red); if an error is detected, the red backlight is activated automatically (function can be disabled)
- Operating range: -15...50 °C/+5...122 °F
- Degree of protection: IP 65
- Trend curves: Graphic display of changes over time in monitoring variables, energy data, and process data
- Graphic display of a pump's dynamic operation in relation to its optimum operation
- Embedded dynamic QR codes for contextual, instantaneous access to online help (diagnostics and settings, etc.) using a smartphone or tablet
- Real-time clock with 10-year backup battery providing data acquisition and event timestamping functions even when the drive is stopped

Description

Display:

- 8 lines, 240 x 160 pixels
- Displays bar charts, gauges, and trend charts
- 4 function keys to facilitate navigation and provide contextual links for enabling functions
- "STOP/RESET" button: Local control of motor stop command/clearing detected faults
- "RUN" button: Local control of motor run command
- Navigation buttons:
 - OK button: Saves the current value (ENT)
 - Turn ±: Increases or decreases the value, goes to the next or previous line
 - "ESC" button: Aborts a value, parameter, or menu to return to the previous selection
 - Home: Root menu
 - Information (i): Contextual help

References

Description	Reference	Weight kg/ lb
Graphic display terminal	VW3A1111	0.200/ 0.441

Communication accessory

Description	Reference	Weight kg/ lb
IP 20 Wi-Fi dongle Remote mounting of the Ethernet port for connection of Wi-Fi equipment (PC, tablet, smartphone, etc.) powered by internal rechargeable battery	TCSEGWB13FA0	0.350/ 0.772

(1) Graphic display terminal used only as a handheld terminal.

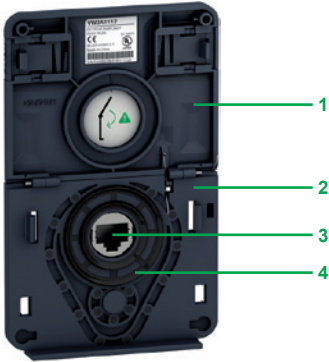

Remote mounting kit for mounting graphic display terminal on enclosure door (front panel)

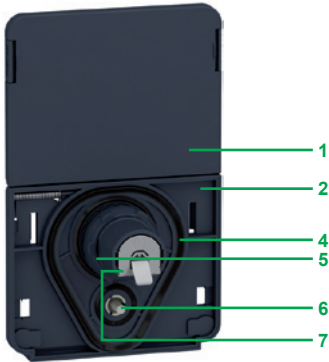

Remote mounting kit for graphic display terminal (rear panel)

Accessories for graphic display terminal

- Remote mounting kit for mounting on enclosure door with IP 65/UL Type 12 degree of protection as standard

The kit comprises:

- Tightening tool (also sold separately under the reference ZB5AZ905)

1 Cover plate to maintain IP 65 protection when there is no terminal connected

2 Mounting plate

3 RJ45 port for the graphic display terminal

4 Seal

5 Fixing nut

6 Anti-rotation pin

7 RJ45 port for connecting the remote-mounting cordset (10 m/32.81 ft maximum)
Cordsets should be ordered separately depending on the length required.

8 Grounding connector

Drilling a hole with a standard Ø 22 tool, as used for a pushbutton, allows the unit to be mounted without needing a cut-out in the enclosure (Ø 22.5 mm/Ø 0.89 in. drill hole).

References

Description	Length m/ ft	IP	Reference	Weight kg/ lb
Remote mounting kit Order with remote-mounting cordset VW3A1104R●●●	–	65/UL Type 12	VW3A1112	–
Tightening tool for remote mounting kit	–	–	ZB5AZ905	0.016/ 0.035
Remote-mounting cordset equipped with 2 RJ45 connectors	1/ 3.28 3/ 9.84 5/ 16.40 10/ 32.81	–	VW3A1104R10 VW3A1104R30 VW3A1104R50 VW3A1104R100	0.050/ 0.110 0.150/ 0.331 0.250/ 0.551 0.500/ 1.102
USB/Mini B USB cable for connecting the display terminal to a PC	–	–	TCSXCNAMUM3P	–

IP 65 remote mounting kit for Ethernet port (1)
Ø 22 RJ45 female/female adapter with seal

Set of 10 x IP55 shutters for ATV650:
to keep IP55 protection level when the
graphic display terminal is removed

Multidrop connection accessories

These accessories are used to connect a graphic display terminal to several drives via a multidrop link. This multidrop connection uses the RJ45 terminal port on the front of the drive.

Connection accessories

Description		Sold in lots of	Unit reference	Weight kg/ lb
Modbus splitter box 10 RJ45 connectors and 1 screw terminal block		–	LU9GC3	0.500/ 1.102
Modbus T-junction boxes	With 0.3 m/0.98 ft integrated cable	–	VW3A8306TF03	0.190/ 0.419
	With 1 m/3.28 ft integrated cable	–	VW3A8306TF10	0.210/ 0.463
Modbus line terminator	For RJ45 connector	R = 120 Ω C = 1 nf	VW3A8306RC	0.010/ 0.022

Cordsets (equipped with 2 RJ45 connectors)

Used for	Length m/ ft	Reference	Weight kg/ lb
Serial link	0.3/ 0.98	VW3A8306R03	0.025/ 0.055
	1/ 3.28	VW3A8306R10	0.060/ 0.132
	3/ 9.84	VW3A8306R30	0.130/ 0.287

(1) Used to connect a remote PC to the RJ45 port on an IP 21 drive mounted in an enclosure or on a wall. Drill hole with a standard Ø 22 tool, as used for a pushbutton. (Requires a remote-mounting cordset VW3A1104R●●● equipped with 2 RJ45 connectors).

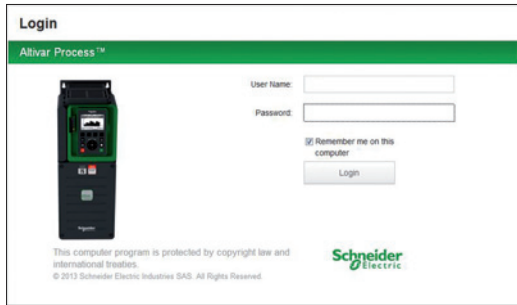

Login screen



Customizable widgets



Pump curves

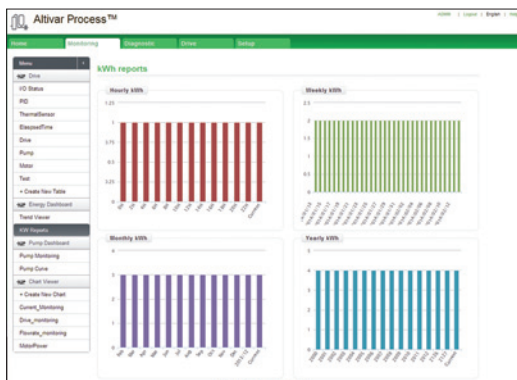

Energy dashboard

Web server

Presentation

- The Web server can be accessed:
 - For a drive not connected to an Ethernet network:
 - Via an Ethernet cable or the Schneider Electric Wi-Fi dongle (the drive then appears as a network device)
 - For a drive connected to an Ethernet network:
 - From any point on the network by entering the drive IP address
- The Web server is used for:
 - Commissioning the drive (setting configuration parameters and enabling the main functions)
 - Monitoring energy and process data, as well as drive and motor data
 - Diagnostics (drive status, file transfer, detected error and warning logs)

Description

The Web server is structured around 5 tabs.

- “My dashboard” tab:
 - Configurable using a wide choice of widgets; groups all the information and dashboards selected by the user on one page
 - “Display” tab:
 - Monitors energy indicators, efficiency, and performance
 - Displays process data such as optimum pump operation
 - Monitors drive parameters and status
 - Shows the I/O state and assignment
 - “Diagnostics” tab:
 - Drive status
 - Time and date-stamped warning and detected error logs
 - Network diagnostics
 - Access to drive self-tests
 - “Drive” tab:
 - Access to the main drive adjustment parameters with contextual help
 - “Setup” tab:
 - Network configuration
 - Access management
 - Transferring and retrieving drive configurations
 - Exporting data acquisition files and logs
 - Customizing pages (colors, logos, etc.)
- Other characteristics:
- Ease of connection via the RJ45 port or Wi-Fi connection
 - Password-protected authentication (modifiable password; access rights can be configured by administrator)
 - No downloads or installation necessary
 - Web server can be disabled
 - Works in a similar way on PCs, iPhones, iPads, Android systems, and the major web browsers:
 - Internet Explorer® (version 8 or higher)
 - Google Chrome® (version 11 or higher)
 - Mozilla Firefox® (version 4 or higher)
 - Safari® (version 5.1.7 or higher)

DTM

Presentation

Using FDT/DTM technology it is possible to configure, control, and diagnose Altivar Process drives directly in Unity Pro and SoMove software by means of the same software brick (DTM).

FDT/DTM technology standardizes the communication interface between field devices and host systems. The DTM contains a uniform structure for managing drive access parameters.

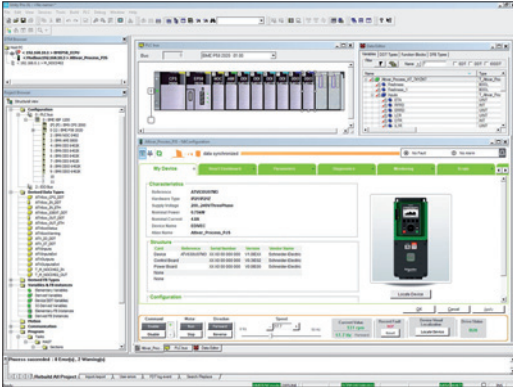

Altivar Process DTM in Unity

Specific functions of the Altivar Process DTM

- Offline or online access to drive data
- Drive firmware updates
- Transfer of configuration files from and to the drive
- Customization (dashboard, My Menu, etc.)
- Access to drive parameters and option cards
- Oscilloscope function
- Graphic interface to assist with configuration of the Altivar Process pump functions
- Energy and process dashboards
- Graphic display of system operation and comparison with optimum operation (pump curves)
- Detected error and warning logs (with time-stamping)

Advantages of the DTM library in Unity Pro:

- Single tool for configuration, setup, and diagnostics
- Network scan for automatic recognition of network configuration
- Ability to add/remove, copy/paste configuration files from other drives in the same architecture
- Single input point for all parameters shared between the ePAC (programmable controller) and the Altivar Process drive
- Creation of drive profiles for implicit communication with the ePAC as well as dedicated profiles for programs with DFBs (derived function blocks)
- Integration in the fieldbus topology
- Drive configuration is an integral part of the Unity Pro project file (STU) and the archive file (STA)

Advantages of the DTM library in SoMove:

- Drive-oriented software environment
- Wired connection to the Ethernet communication port
- Standard cable (file transfer performance)
- Function block library for Unity Pro
- Display blocks for Vijeo Citect

■ Third-party software and downloads:

The Altivar Process DTM library is a flexible, open, and interactive tool that can be used in a third-party FDT.

DTMs can be downloaded from our website www.schneider-electric.com.

SoMove software

Presentation

SoMove software for PC is used to configure, set up, and maintain Altivar Process drives.

In addition to the functions offered by the Web server, SoMove software features the oscilloscope function for accurate display of data samples, as well as access to multi-drive applications.

The software can be connected to Altivar Process variable speed drives via:

- A Bluetooth® wireless connection with the Bluetooth/Modbus adapter TCSWAAC13FB
- Ethernet Modbus and Wi-Fi connection with the Wi-Fi dongle TCSEGWB13FA0
- Ethernet Modbus TCP connection

For more information on SoMove setup software, please consult the “SoMove: Setup Software” catalog available on our website www.schneider-electric.com.



SoMove software

Table showing possible combinations of options for ATV630...M3 and ATV630...N4 drives

Motor kW HP	Drive	Wear parts Fan kit	Options Flange-mounting kit	Passive filters (50 Hz)				Passive filters (60 Hz)				EMC filters	IP 21 kit for EMC filter	dv/dt filters	IP 21 kit for dv/dt filter	Sinus filter	IP 21 kit for sinus filter	Common mode filter (3)
				THDI < 10%	THDI < 5%	THDI < 10%	THDI < 5%	THDI < 10%	THDI < 5%									
Three-phase supply voltage: 200...240 V 50/60 Hz - IP 21/UL Type 1																		
0.75 1	ATV630U07M3	VX5VP50BC001	NSYPTDS1	-	-	-	-	-	-	-	-	VW3A4701	VW3A47901	VW3A5301	VW3A53902	VW3A5401	VW3A53901	VW3A5502
1.5 2	ATV630U15M3	VX5VP50BC001	NSYPTDS1	-	-	-	-	-	-	-	-	VW3A4701	VW3A47901	VW3A5302	VW3A53902	VW3A5402	VW3A53901	VW3A5502
2.2 3	ATV630U22M3	VX5VP50BC001	NSYPTDS1	-	-	-	-	-	-	-	-	VW3A4702	VW3A47902	VW3A5302	VW3A53902	VW3A5402	VW3A53901	VW3A5502
3 -	ATV630U30M3	VX5VP50BC001	NSYPTDS1	-	-	-	-	-	-	-	-	VW3A4702	VW3A47902	VW3A5302	VW3A53902	VW3A5402	VW3A53901	VW3A5502
4 5	ATV630U40M3	VX5VP50BC001	NSYPTDS1	-	-	-	-	-	-	-	-	VW3A4703	VW3A47903	VW3A5303	VW3A53902	VW3A5403	VW3A53902	VW3A5502
5.5 7.5	ATV630U55M3	VX5VPS1001	NSYPTDS2	-	-	-	-	-	-	-	-	VW3A4703	VW3A47903	VW3A5304	VW3A53903	VW3A5404	VW3A53903	VW3A5502
7.5 10	ATV630U75M3	VX5VPS3001	NSYPTDS3	-	-	-	-	-	-	-	-	VW3A4703	VW3A47903	VW3A5304	VW3A53903	VW3A5404	VW3A53903	VW3A5504
11 15	ATV630D11M3	VX5VPS3001	NSYPTDS3	-	-	-	-	-	-	-	-	VW3A4704	VW3A47904	VW3A5304	VW3A53903	VW3A5404	VW3A53903	VW3A5504
15 20	ATV630D15M3	VX5VPS4001	NSYPTDS4	-	-	-	-	-	-	-	-	VW3A4705	VW3A47905	VW3A5305	VW3A53905	VW3A5405	VW3A53904	VW3A5504
18.5 25	ATV630D18M3	VX5VPS4001	NSYPTDS4	-	-	-	-	-	-	-	-	VW3A4706	VW3A47906	VW3A5305	VW3A53905	VW3A5405	VW3A53904	VW3A5504
22 30	ATV630D22M3	VX5VPS4001	NSYPTDS4	-	-	-	-	-	-	-	-	VW3A4706	VW3A47906	VW3A5305	VW3A53905	VW3A5405	VW3A53904	VW3A5504
30 40	ATV630D30M3	VX5VPS5001	NSYPTDS5	-	-	-	-	-	-	-	-	VW3A4707	VW3A47907	VW3A5306	-	VW3A5406	-	VW3A5504
37 50	ATV630D37M3	VX5VPS5001	NSYPTDS5	-	-	-	-	-	-	-	-	VW3A4707	VW3A47907	VW3A5306	-	VW3A5406	-	VW3A5504
45 60	ATV630D45M3	VX5VPS5001	NSYPTDS5	-	-	-	-	-	-	-	-	VW3A4708	VW3A47908	VW3A5306	-	VW3A5406	-	VW3A5504
55 75	ATV630D55M3	VX5VPS6001	-	-	-	-	-	-	-	-	-	VW3A4709	-	VW3A5307	-	-	-	VW3A5506
75 100	ATV630D75M3	VX5VPS6001	-	-	-	-	-	-	-	-	-	VW3A4710	-	VW3A5307	-	VW3A5407 (1)	-	VW3A5506

Three-phase supply voltage: 380...480 V 50/60 Hz - IP 21/UL Type 1

0.75 1	ATV630U07N4	VX5VP50BC001	NSYPTDS1	VW3A46101	VW3A46120	VW3A46139	VW3A46158	-	-	-	-	VW3A4701	VW3A47901	VW3A5301	VW3A53902	VW3A5401	VW3A53901	VW3A5502
1.5 2	ATV630U15N4	VX5VP50BC001	NSYPTDS1	VW3A46101	VW3A46120	VW3A46139	VW3A46158	-	-	-	-	VW3A4701	VW3A47901	VW3A5301	VW3A53902	VW3A5401	VW3A53901	VW3A5502
2.2 3	ATV630U22N4	VX5VP50BC001	NSYPTDS1	VW3A46101	VW3A46120	VW3A46139	VW3A46158	-	-	-	-	VW3A4701	VW3A47901	VW3A5301	VW3A53902	VW3A5401	VW3A53901	VW3A5502
3 -	ATV630U30N4	VX5VP50BC001	NSYPTDS1	VW3A46101	VW3A46120	VW3A46139	VW3A46158	-	-	-	-	VW3A4702	VW3A47902	VW3A5302	VW3A53902	VW3A5402	VW3A53901	VW3A5502
4 5	ATV630U40N4	VX5VP50BC001	NSYPTDS1	VW3A46102	VW3A46121	VW3A46140	VW3A46159	-	-	-	-	VW3A4702	VW3A47902	VW3A5302	VW3A53902	VW3A5402	VW3A53901	VW3A5502
5.5 7.5	ATV630U55N4	VX5VP50BC001	NSYPTDS1	VW3A46102	VW3A46121	VW3A46140	VW3A46159	-	-	-	-	VW3A4702	VW3A47902	VW3A5302	VW3A53902	VW3A5402	VW3A53901	VW3A5502
7.5 10	ATV630U75N4	VX5VPS1001	NSYPTDS2	VW3A46103	VW3A46122	VW3A46141	VW3A46160	-	-	-	-	VW3A4703	VW3A47903	VW3A5303	VW3A53902	VW3A5403	VW3A53902	VW3A5502
11 15	ATV630D11N4	VX5VPS1001	NSYPTDS2	VW3A46104	VW3A46123	VW3A46142	VW3A46161	-	-	-	-	VW3A4703	VW3A47903	VW3A5303	VW3A53902	VW3A5403	VW3A53902	VW3A5502
15 20	ATV630D15N4	VX5VPS3001	NSYPTDS3	VW3A46105	VW3A46124	VW3A46143	VW3A46162	-	-	-	-	VW3A4703	VW3A47903	VW3A5304	VW3A53903	VW3A5404	VW3A53903	VW3A5504
18.5 25	ATV630D18N4	VX5VPS3001	NSYPTDS3	VW3A46106	VW3A46125	VW3A46144	VW3A46163	-	-	-	-	VW3A4704	VW3A47904	VW3A5304	VW3A53903	VW3A5404	VW3A53903	VW3A5504
22 30	ATV630D22N4	VX5VPS3001	NSYPTDS3	VW3A46107	VW3A46126	VW3A46145	VW3A46164	-	-	-	-	VW3A4704	VW3A47904	VW3A5304	VW3A53903	VW3A5404	VW3A53903	VW3A5504
30 40	ATV630D30N4	VX5VPS4001	NSYPTDS4	VW3A46108	VW3A46127	VW3A46146	VW3A46165	-	-	-	-	VW3A4705	VW3A47905	VW3A5305	VW3A53905	VW3A5405	VW3A53904	VW3A5504
37 50	ATV630D37N4	VX5VPS4001	NSYPTDS4	VW3A46109	VW3A46128	VW3A46147	VW3A46166	-	-	-	-	VW3A4706	VW3A47906	VW3A5305	VW3A53905	VW3A5405	VW3A53904	VW3A5504
45 60	ATV630D45N4	VX5VPS4001	NSYPTDS4	VW3A46110	VW3A46129	VW3A46148	VW3A46167	-	-	-	-	VW3A4706	VW3A47906	VW3A5305	VW3A53905	VW3A5405	VW3A53904	VW3A5504
55 75	ATV630D55N4	VX5VPS5001	NSYPTDS5	VW3A46111	VW3A46130	VW3A46149	VW3A46168	-	-	-	-	VW3A4707	VW3A47907	VW3A5306	-	VW3A5406	-	VW3A5504
75 100	ATV630D75N4	VX5VPS5001	NSYPTDS5	VW3A46112	VW3A46131	VW3A46150	VW3A46169	-	-	-	-	VW3A4708	VW3A47908	VW3A5306	-	VW3A5406	-	VW3A5504
90 125	ATV630D90N4	VX5VPS5001	NSYPTDS5	VW3A46113	VW3A46132	VW3A46151	VW3A46170	-	-	-	-	VW3A4708	VW3A47908	VW3A5306	-	VW3A5406	-	VW3A5504
110 150	ATV630C11N4	VX5VPS6001	-	VW3A46114	VW3A46133	VW3A46152	VW3A46171	-	-	-	-	VW3A4709	-	VW3A5307	-	-	-	VW3A5506
132 200	ATV630C13N4	VX5VPS6001	-	VW3A46115	VW3A46134	VW3A46153	VW3A46172	-	-	-	-	VW3A4709	-	VW3A5307	-	VW3A5407 (1)	-	VW3A5506
160 250	ATV630C16N4	VX5VPS6001	-	VW3A46116	VW3A46135	VW3A46154	VW3A46173	-	-	-	-	VW3A4710	-	VW3A5307	-	VW3A5407 (1)	-	VW3A5506
220 350	ATV630C22N4	VZ3V1212 (2)	-	VW3A46118	VW3A46137	VW3A46155	VW3A46174	-	-	-	-	VW3A4411	-	VW3A5106	-	VW3A5209	-	-
250 400	ATV630C25N4	VZ3V1212 (2)	-	VW3A46119	VW3A46138	VW3A46157	VW3A46176	-	-	-	-	VW3A4411	-	VW3A5107	-	VW3A5210	-	-
310 500	ATV630C31N4	VZ3V1212 (2)	-	VW3A46116*2	VW3A46135*2	VW3A46153*2	VW3A46172*2	-	-	-	-	VW3A4411	-	VW3A5107	-	VW3A5210	-	-

Pages	16	21	21	43	44	45	46
--------------	----	----	----	----	----	----	----

(1) In "Normal Duty", apply a derating of 1 to the drive nominal power with a minimum switching frequency of 4 kHz. For example: an ATV630D75M3 drive with sinus filter can be used on a 55 kW motor.

(2) Fan power electronic for drive, with 1 unit for ATV630C22N4, 2 units for ATV630C25N4, and 3 units for ATV630C31N4.

48	49	50	51	52	53	54
----	----	----	----	----	----	----

(3) This combination table is given for a maximum length of 300 m with an unshielded cable. For other lengths, or for shielded cables, see page 54.

Table showing possible combinations of options for ATV650●●●N4 and ATV650●●●N4E drives

Motor kW HP	Drive	Wear parts Fan kit	Options				EMC filters	IP 21 kit for EMC filter	dv/dt filters	IP 21 kit for dv/dt filter	Sinus filter	IP 21 kit for sinus filter	Common mode filter (5)	
			Flange-mounting kit	Passive filters (50 Hz)		Passive filters (60 Hz)								
				THDI < 10%	THDI < 5%	THDI < 10%	THDI < 5%							
Three-phase supply voltage: 380...480 V 50/60 Hz - IP 55														
0.75 1	ATV650U07N4	VX5VP50A001	–	VW3A46101 (1)	VW3A46120 (1)	VW3A46139 (1)	VW3A46158 (1)	VW3A4701	–	VW3A5301	–	VW3A5401 (1)	–	VW3A5502
1.5 2	ATV650U15N4	VX5VP50A001	–	VW3A46101 (1)	VW3A46120 (1)	VW3A46139 (1)	VW3A46158 (1)	VW3A4701	–	VW3A5301	–	VW3A5401 (1)	–	VW3A5502
2.2 3	ATV650U22N4	VX5VP50A001	–	VW3A46101 (1)	VW3A46120 (1)	VW3A46139 (1)	VW3A46158 (1)	VW3A4701	–	VW3A5301	–	VW3A5401 (1)	–	VW3A5502
3 –	ATV650U30N4	VX5VP50A001	–	VW3A46101 (1)	VW3A46120 (1)	VW3A46139 (1)	VW3A46158 (1)	VW3A4702	–	VW3A5302	–	VW3A5402 (1)	–	VW3A5502
4 5	ATV650U40N4	VX5VP50A001	–	VW3A46102 (1)	VW3A46121 (1)	VW3A46140 (1)	VW3A46159 (1)	VW3A4702	–	VW3A5302	–	VW3A5402 (1)	–	VW3A5502
5.5 7.5	ATV650U55N4	VX5VP50A001	–	VW3A46102 (1)	VW3A46121 (1)	VW3A46140 (1)	VW3A46159 (1)	VW3A4702	–	VW3A5302	–	VW3A5402 (1)	–	VW3A5502
7.5 10	ATV650U75N4	VX5VP50A001	–	VW3A46103 (1)	VW3A46122 (1)	VW3A46141 (1)	VW3A46160 (1)	VW3A4703	–	VW3A5303	–	VW3A5403 (1)	–	VW3A5502
11 15	ATV650D11N4	VX5VP50A001	–	VW3A46104 (1)	VW3A46123 (1)	VW3A46142 (1)	VW3A46161 (1)	VW3A4703	–	VW3A5303	–	VW3A5403 (1)	–	VW3A5502
15 20	ATV650D15N4	VX5VP50A001	–	VW3A46105 (1)	VW3A46124 (1)	VW3A46143 (1)	VW3A46162 (1)	VW3A4703	–	VW3A5304	–	VW3A5404 (1)	–	VW3A5504
18.5 25	ATV650D18N4	VX5VP50A001	–	VW3A46106 (1)	VW3A46125 (1)	VW3A46144 (1)	VW3A46163 (1)	VW3A4704	–	VW3A5304	–	VW3A5404 (1)	–	VW3A5504
22 30	ATV650D22N4	VX5VP50A001	–	VW3A46107 (1)	VW3A46126 (1)	VW3A46145 (1)	VW3A46164 (1)	VW3A4704	–	VW3A5304	–	VW3A5404 (1)	–	VW3A5504
30 40	ATV650D30N4	VX5VP50BC001	–	VW3A46108 (1)	VW3A46127 (1)	VW3A46146 (1)	VW3A46165 (1)	VW3A4705	–	VW3A5305	–	VW3A5405 (1)	–	VW3A5504
37 50	ATV650D37N4	VX5VP50BC001	–	VW3A46109 (1)	VW3A46128 (1)	VW3A46147 (1)	VW3A46166 (1)	VW3A4706	–	VW3A5305	–	VW3A5405 (1)	–	VW3A5504
45 60	ATV650D45N4	VX5VP50BC001	–	VW3A46110 (1)	VW3A46129 (1)	VW3A46148 (1)	VW3A46167 (1)	VW3A4706	–	VW3A5305	–	VW3A5405 (1)	–	VW3A5504
55 75	ATV650D55N4	VX5VP50BC001	–	VW3A46111 (1)	VW3A46130 (1)	VW3A46149 (1)	VW3A46168 (1)	VW3A4707	–	VW3A5306	–	VW3A5406 (1)	–	VW3A5504
75 100	ATV650D75N4	VX5VP50BC001	–	VW3A46112 (1)	VW3A46131 (1)	VW3A46150 (1)	VW3A46169 (1)	VW3A4708	–	VW3A5306	–	VW3A5406 (1)	–	VW3A5504
90 125	ATV650D90N4	VX5VP50BC001	–	VW3A46113 (1)	VW3A46132 (1)	VW3A46151 (1)	VW3A46170 (1)	VW3A4708	–	VW3A5306	–	VW3A5406 (1)	–	VW3A5504
Three-phase supply voltage: 380...480 V 50/60 Hz - IP 55 with Vario disconnect switch														
0.75 1	ATV650U07N4E	VX5VP50A001	–	VW3A46101 (1)	VW3A46120 (1)	VW3A46139 (1)	VW3A46158 (1)	VW3A4701	–	VW3A5301	–	VW3A5401 (1)	–	VW3A5502
1.5 2	ATV650U15N4E	VX5VP50A001	–	VW3A46101 (1)	VW3A46120 (1)	VW3A46139 (1)	VW3A46158 (1)	VW3A4701	–	VW3A5301	–	VW3A5401 (1)	–	VW3A5502
2.2 3	ATV650U22N4E	VX5VP50A001	–	VW3A46101 (1)	VW3A46120 (1)	VW3A46139 (1)	VW3A46158 (1)	VW3A4701	–	VW3A5301	–	VW3A5401 (1)	–	VW3A5502
3 –	ATV650U30N4E	VX5VP50A001	–	VW3A46101 (1)	VW3A46120 (1)	VW3A46139 (1)	VW3A46158 (1)	VW3A4702	–	VW3A5302	–	VW3A5402 (1)	–	VW3A5502
4 5	ATV650U40N4E	VX5VP50A001	–	VW3A46102 (1)	VW3A46121 (1)	VW3A46140 (1)	VW3A46159 (1)	VW3A4702	–	VW3A5302	–	VW3A5402 (1)	–	VW3A5502
5.5 7.5	ATV650U55N4E	VX5VP50A001	–	VW3A46102 (1)	VW3A46121 (1)	VW3A46140 (1)	VW3A46159 (1)	VW3A4702	–	VW3A5302	–	VW3A5402 (1)	–	VW3A5502
7.5 10	ATV650U75N4E	VX5VP50A001	–	VW3A46103 (1)	VW3A46122 (1)	VW3A46141 (1)	VW3A46160 (1)	VW3A4703	–	VW3A5303	–	VW3A5403 (1)	–	VW3A5502
11 15	ATV650D11N4E	VX5VP50A001	–	VW3A46104 (1)	VW3A46123 (1)	VW3A46142 (1)	VW3A46161 (1)	VW3A4703	–	VW3A5303	–	VW3A5403 (1)	–	VW3A5502
15 20	ATV650D15N4E	VX5VP50A001	–	VW3A46105 (1)	VW3A46124 (1)	VW3A46143 (1)	VW3A46162 (1)	VW3A4703	–	VW3A5304	–	VW3A5404 (1)	–	VW3A5504
18.5 25	ATV650D18N4E	VX5VP50A001	–	VW3A46106 (1)	VW3A46125 (1)	VW3A46144 (1)	VW3A46163 (1)	VW3A4704	–	VW3A5304	–	VW3A5404 (1)	–	VW3A5504
22 30	ATV650D22N4E	VX5VP50A001	–	VW3A46107 (1)	VW3A46126 (1)	VW3A46145 (1)	VW3A46164 (1)	VW3A4704	–	VW3A5304	–	VW3A5404 (1)	–	VW3A5504
30 40	ATV650D30N4E	VX5VP50BC001	–	VW3A46108 (1)	VW3A46127 (1)	VW3A46146 (1)	VW3A46165 (1)	VW3A4705	–	VW3A5305	–	VW3A5405 (1)	–	VW3A5504
37 50	ATV650D37N4E	VX5VP50BC001	–	VW3A46109 (1)	VW3A46128 (1)	VW3A46147 (1)	VW3A46166 (1)	VW3A4706	–	VW3A5305	–	VW3A5405 (1)	–	VW3A5504
45 60	ATV650D45N4E	VX5VP50BC001	–	VW3A46110 (1)	VW3A46129 (1)	VW3A46148 (1)	VW3A46167 (1)	VW3A4706	–	VW3A5305	–	VW3A5405 (1)	–	VW3A5504
55 75	ATV650D55N4E	VX5VP50BC001	–	VW3A46111 (1)	VW3A46130 (1)	VW3A46149 (1)	VW3A46168 (1)	VW3A4707	–	VW3A5306	–	VW3A5406 (1)	–	VW3A5504
75 100	ATV650D75N4E	VX5VP50BC001	–	VW3A46112 (1)	VW3A46131 (1)	VW3A46150 (1)	VW3A46169 (1)	VW3A4708	–	VW3A5306	–	VW3A5406 (1)	–	VW3A5504
90 125	ATV650D90N4E	VX5VP50BC001	–	VW3A46113 (1)	VW3A46132 (1)	VW3A46151 (1)	VW3A46170 (1)	VW3A4708	–	VW3A5306	–	VW3A5406 (1)	–	VW3A5504
Pages	16	21	21	43	44	45	46	48	49	50	51	52	53	54

I/O expansion modules

Description	Reference	Page
Module with digital and analog I/O	VW3A3203	33
Module with relay outputs	VW3A3204	33

List of communication modules (2)

Description	Reference	Page
EtherNet/IP and Modbus TCP dual port	VW3A3720	37
EtherNet/IP, Modbus TCP and MD-Link dual port	VW3A3721	37
CANopen Daisy chain	VW3A3608	38
CANopen SUB-D	VW3A3618	38
CANopen screw terminal block	VW3A3628	39
PROFINET	VW3A3627	40
PROFIBUS DP V1	VW3A3607	40
DeviceNet	VW3A3609	41

(1) When used with ATV650U07N4/N4E...D90N4/N4E drives, the filter must be mounted in a separate enclosure to maintain IP 55 protection for the installation.
 (2) For module compatibility table, see opposite.

Module compatibility table

Module type	Digital and analog I/O VW3A3203 (3)	Relay outputs VW3A3204 (3)	Communication VW3A372● and VW3A36●● (4)
Digital and analog I/O VW3A3203			
Relay outputs VW3A3204			
Communication VW3A372● and VW3A36●●			

 Combination possible

 Combination impossible

(3) Maximum combination involving two types of module is 2.
 (4) Maximum combination involving two types of module is 1.
 (5) This combination table is given for a maximum length of 300 m with an unshielded cable. For other lengths, or for shielded cables, see page 54.

PF140354

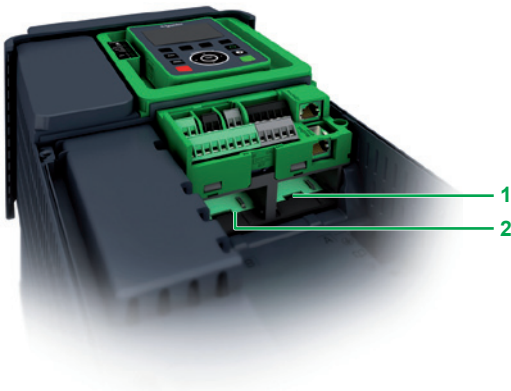

I/O expansion modules

Presentation

By installing I/O expansion modules Altivar Process drives can be adapted to meet the needs of applications that manage additional sensors or specific sensors.

2 expansion modules are available:

- Module with digital and analog I/O
- Module with relay outputs

These modules are inserted in slots A and B on Altivar Process drives:

- 1 Slot A for I/O expansion or communication modules
- 2 Slot B for I/O expansion modules

Module with digital and analog I/O

- 2 differential analog inputs configurable via software as current (0-20 mA/4-20 mA), or for PTC, PT100 or PT1000, 2 or 3-wire
- 14-bit resolution
- 6 x 24 V $\bar{}$ positive or negative digital inputs
- Sampling: 1 ms max
- 2 assignable digital outputs
- 2 removable spring terminal blocks

Module with relay outputs

- 3 relay outputs with NO contacts
- 1 fixed screw terminal block

Note: Digital and analog I/O modules and relay output modules can go in either slot A or slot B on Altivar Process drives.

However, the drives cannot take 2 modules of the same type (e.g., 2 digital and analog I/O modules or 2 relay output modules).

PF130896



VW3A3203

PF130897



VW3A3204

I/O expansion modules

Description	I/O type				Reference	Weight kg/ lb
	Digital inputs	Digital outputs	Analog inputs	Relay outputs		
Module with digital and analog I/O	6	2	2 (1)	–	VW3A3203	–
Module with relay outputs	–	–	–	3 (2)	VW3A3204	–

(1) Differential analog inputs configurable via software as current 0-20 mA/4-20 mA), or for PTC, PT100 or PT1000, 2 or 3-wire. When configured as PTC probe inputs, they must never be used to protect an ATEX motor in applications in explosive atmospheres. Please refer to the ATEX guide on our website www.schneider-electric.com.

(2) NO contacts.

Presentation

Altivar Process drives have 3 built-in RJ45 communication ports as standard:

- 1 Ethernet port
- 2 serial ports

Integrated communication protocols

Altivar Process drives integrate the Modbus TCP and Modbus serial link communication protocols as standard.

■ Ethernet port

This offers standard services regularly used in industrial networks:

- Modbus TCP message handling is based on the Modbus protocol and is used to exchange process data with other network devices (e.g., a PLC). It provides Altivar Process drives with access to the Modbus protocol and to the high performance of the Ethernet network, which is the communication standard for numerous devices.
- SNMP (Simple Network Management Protocol) offers standard diagnostics services for network management tools.
- The FDR (Fast Device Replacement) service allows automatic reconfiguration of a new device installed to replace an existing device.
- Device security is reinforced by disabling some unused services as well as managing a list of authorized devices.
- Setup and adjustment tools (SoMove, Unity with DTM) can be connected locally or remotely.
- The embedded Web server is used to display operating data and dashboards as well as to configure and diagnose system elements from any web browser.

These numerous services offered by the Ethernet port mean that Altivar Process drives can be integrated into Schneider Electric solutions.

■ Serial ports

- One port dedicated to field network operation for exchanging data with other devices via the Modbus protocol
- A second dedicated port for the multidrop connection of the following HMIs and configuration tools:
 - The remote graphic display terminal supplied with the drive
 - A Magelis industrial HMI terminal
 - A PC with SoMove or Unity setup software

The detailed specifications for the Ethernet or serial communication ports, and the Modbus and Modbus TCP protocols are available on our website www.schneider-electric.com.

Description

- 1 RJ45 Ethernet port
- 2 RJ45 serial port
- 3 Slot A for I/O expansion or communication modules
- 4 Slot B for I/O expansion modules
- 5 Removable screw terminal blocks for 24 V $\bar{\text{---}}$ power supply and integrated I/O
- 6 RJ45 serial link for HMI (remote graphic display terminal, Magelis terminal, etc.)

Altivar Process drives can only take one communication module, in slot A **3** only. They cannot take 2 modules of the same type (e.g., 2 digital and analog I/O modules or 2 relay output modules). The drives can take 1 digital and analog I/O module and 1 relay output module in either slot A **3** or slot B **4**.

Note: The user manuals and description files (*gsd*, *eds*, *xif*) for the devices on the communication buses and networks are available on our website www.schneider-electric.com.

PFI140354

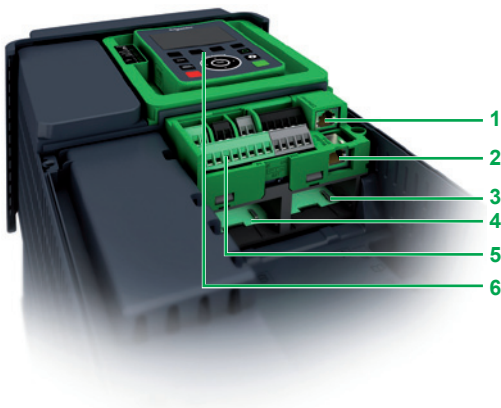

Optional communication modules

The Altivar Process drive can also be connected to other industrial communication buses and networks by using one of the communication modules available as an option. Communication cards are supplied in "cassette" format for ease of mounting/removal.

Dedicated communication modules:

- EtherNet/IP and Modbus TCP Dual port
- CANopen:
 - RJ45 Daisy Chain
 - Sub-D
 - Screw terminal block
- PROFINET
- PROFIBUS DP V1
- DeviceNet

PROFINET and PROFIBUS DP V1 modules also support the Profidrive and CiA402 profiles.

It is possible to maintain communication using a separate power supply for the control and power sections. Monitoring and diagnostics are possible via the network even if there is no power supply to the power section.

Functions

The drive functions can be accessed via the various communication networks:

- Configuration
- Adjustment
- Control
- Monitoring

Altivar Process drives offer a high degree of interfacing flexibility with the possibility to assign, by configuration, the different control sources (I/O, communication networks, and HMI terminal) to control functions in order to meet the requirements of complex applications.

Network services and parameters are configured using the SoMove drive setup software, or using Unity software if the drive is being integrated into a PlantStruXure architecture.

Communication is monitored according to the specific criteria for each protocol. However, regardless of the protocol, it is possible to configure how the drive responds to a detected communication interruption, as follows:

- Define the type of stop when a communication interruption is detected
- Maintain last command received
- Fallback position at preset speed
- Ignore the detected communication interruption

Variable speed drives

Altivar Process

Communication buses and networks

Integrated ports

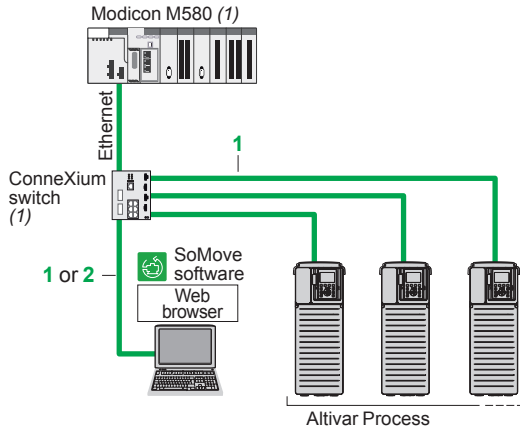

Example of Ethernet architecture

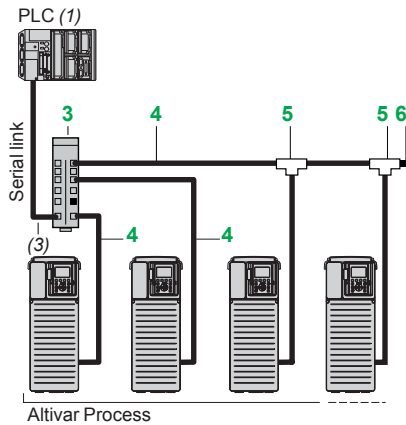

Example of serial link architecture

Integrated Ethernet port

Description	Item	Length m/ ft	Unit reference	Weight kg/ lb
ConneXium cordsets (2)				
Straight shielded twisted pair cables equipped with 2 RJ45 connectors conforming to EIA/TIA-568 category 5 and IEC 11801/EN 50173-1, class D	1	2/ 6.56	490NTW00002	–
		5/ 16.40	490NTW00005	–
		12/ 39.37	490NTW00012	–
Crossover shielded twisted pair cables equipped with 2 RJ45 connectors conforming to EIA/TIA-568 category 5 and IEC 11801/EN 50173-1, class D	2	5/ 16.40	490NTC00005	–
		15/ 49.21	490NTC00015	–
Straight shielded twisted pair cables equipped with 2 RJ45 connectors conforming to UL and CSA 22.1	1	2/ 6.56	490NTW00002U	–
		5/ 16.40	490NTW00005U	–
		12/ 39.37	490NTW00012U	–
Crossover shielded twisted pair cables equipped with 2 RJ45 connectors conforming to UL and CSA 22.1	2	5/ 16.40	490NTC00005U	–
		15/ 49.21	490NTC00015U	–

Integrated serial port

Description	Item	Length m/ ft	Unit reference	Weight kg/ lb		
Connection accessories						
Splitter box 10 RJ45 connectors and 1 screw terminal block	3	–	LU9GC3	0.500/ 1.102		
Modbus T-junction boxes		With 0.3 m/0.98 ft integrated cable	5	0.3/ 0.98	VW3A8306TF03	0.190/ 0.419
		With 1 m/3.28 ft integrated cable	5	1/ 3.28	VW3A8306TF10	0.210/ 0.463
Modbus line terminator (4)		For RJ45 connector	6	R = 120 Ω C = 1 nf	VW3A8306RC	0.010/ 0.022
Cordsets equipped with 2 RJ45 connectors		0.3/ 0.98	4		VW3A8306R03	0.025/ 0.055
		1/ 3.28			VW3A8306R10	0.060/ 0.132
		3/ 9.84			VW3A8306R30	0.130/ 0.287

- (1) Please refer to the "Modicon automation platform" catalogs on our website www.schneider-electric.com.
- (2) Also exist in 40 and 80 m/131 and 262 ft lengths. For other ConneXium connection accessories, please consult our website www.schneider-electric.com.
- (3) Cable depends on the PLC.
- (4) Sold in lots of 2.

Variable speed drives

Altivar Process

Communication buses and networks

Option: Communication modules

PF130914A



VW3A3720

EtherNet/IP and Modbus TCP networks (1)

Description	Item	Length m/ ft	Unit reference	Weight kg/ lb
Communication module				
EtherNet/IP and Modbus TCP dual port module For connection to the Modbus TCP or EtherNet/IP network Ports: 2 RJ45 connectors ■ 10/100 Mbps, half duplex and full duplex ■ embedded Web server Requires cordset 490NTW000●●/●●U or 490NTC000●●/●●U	1	–	VW3A3720	0.020/ 0.044
EtherNet/IP, Modbus TCP, and MD-Link dual port module For connection to the Modbus TCP or EtherNet/IP network and MultiDrive-Link Ports: 2 RJ45 connectors ■ 10/100 Mbps, half duplex and full duplex ■ embedded Web server Requires cordset 490NTW000●●/●●U or 490NTC000●●/●●U	4	–	VW3A3721	0.020/ 0.044

Modicon M580 (2)

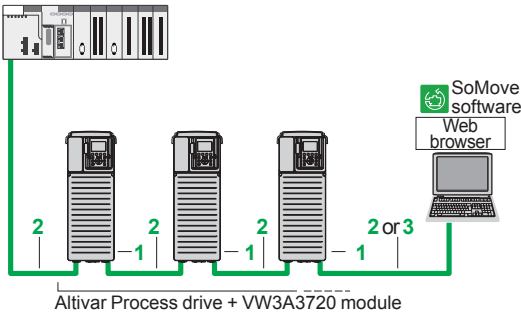

Example of connection on an EtherNet/IP network

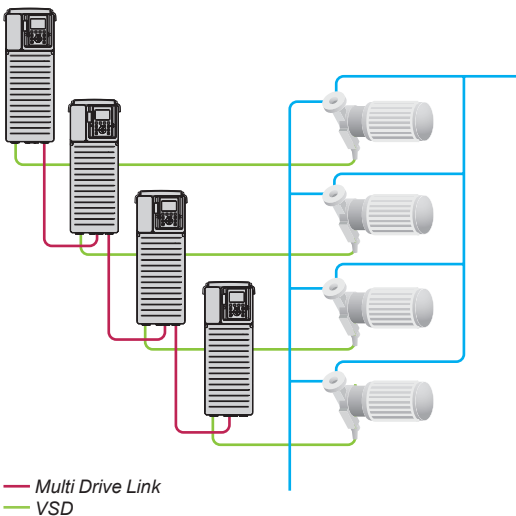

— Multi Drive Link
— VSD

ConneXium cordsets (3)

Straight shielded twisted pair cables equipped with 2 RJ45 connectors conforming to EIA/TIA-568 category 5 and IEC 11801/EN 50173-1, class D	2	2/ 6.56	490NTW00002	–
		5/ 16.40	490NTW00005	–
		12/ 39.37	490NTW00012	–
Crossover shielded twisted pair cables equipped with 2 RJ45 connectors conforming to EIA/TIA-568 category 5 and IEC 11801/EN 50173-1, class D	3	5/ 16.40	490NTC00005	–
		15/ 49.21	490NTC00015	–
Straight shielded twisted pair cables equipped with 2 RJ45 connectors conforming to UL and CSA 22.1	2	2/ 6.56	490NTW00002U	–
		5/ 16.40	490NTW00005U	–
		12/ 39.37	490NTW00012U	–
Crossover shielded twisted pair cables equipped with 2 RJ45 connectors conforming to UL and CSA 22.1	3	5/ 16.40	490NTC00005U	–
		15/ 49.21	490NTC00015U	–

(1) Altivar Process drives can only take one communication module.

(2) Please refer to the "M580 automation platform" catalog on our website www.schneider-electric.com.

(3) Also exist in 40 and 80 m/131 and 262 ft lengths. For other ConneXium connection accessories, please consult our website www.schneider-electric.com.

Variable speed drives

Altivar Process

Communication buses and networks

Option: Communication modules



VW3A3608



VW3A3618

PLC (2)

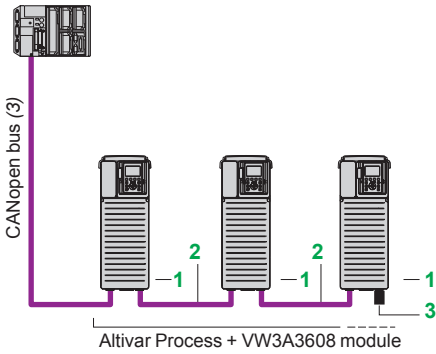

Optimized solution for daisy chain connection to the CANopen bus

PLC (2)

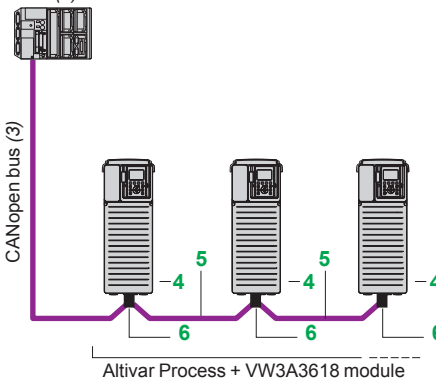

Example of connection to the CANopen bus via SUB-D connector

CANopen bus (1)

Description	Item	Length m/ ft	Unit reference	Weight kg/ lb
Communication module				
CANopen Daisy chain module Ports: 2 RJ45 connectors	1	-	VW3A3608	-

Connection to RJ45 connector (optimized solution for daisy chain connection on CANopen bus)

CANopen cordsets equipped with 2 RJ45 connectors	2	0.3/ 0.98	VW3CANCARR03	0.050/ 0.110
		1/ 3.28	VW3CANCARR1	0.500/ 1.102
CANopen line terminator for RJ45 connector	3	-	TCSCAR013M120	-

Communication module

CANopen SUB-D module Ports: 1 x 9-way male SUB-D connector	4	-	VW3A3618	-
--	---	---	----------	---

Connection to SUB-D connector

CANopen cables (3) (4) Standard cable, C€ mark Low smoke zero halogen. Flame-retardant (IEC 60332-1)	5	50/ 164.04	TSXCANCA50	4.930/ 10.869
		100/ 328.08	TSXCANCA100	8.800/ 19.401
		300/ 984.25	TSXCANCA300	24.560/ 54.145
CANopen cables (3) (4) UL certification, C€ mark Flame-retardant (IEC 60332-2)	5	50/ 164.04	TSXCANCB50	3.580/ 7.893
		100/ 328.08	TSXCANCB100	7.840/ 17.284
		300/ 984.25	TSXCANCB300	21.870/ 48.215
CANopen cables (3) (4) Cable for harsh environments or mobile installations, C€ mark Low smoke zero halogen Flame-retardant (IEC 60332-1)	5	50/ 164.04	TSXCANCD50	3.510/ 7.738
		100/ 328.08	TSXCANCD100	7.770/ 17.130
		300/ 984.25	TSXCANCD300	7.770/ 17.130

IP 20 straight CANopen connector (5) 9-way female SUB-D connector with line terminator that can be deactivated For connecting CAN-H, CAN-L, CAN-GND	6	-	TSXCANKCDF180T	0.049/ 0.108
--	---	---	----------------	-----------------

- (1) Altivar Process drives can only take one communication module.
- (2) Please refer to the "Modicon automation platform" catalogs on our website www.schneider-electric.com.
- (3) Cable depends on the PLC.
- (4) Standard environment:
 - No particular environmental constraints
 - Operating temperature between 5 °C and 60 °C/41 °F and 140 °F
 - Fixed installation
 Harsh environment:
 - Resistance to hydrocarbons, industrial oils, detergents, solder splashes
 - Relative humidity up to 100%
 - Saline atmosphere
 - Operating temperature between -10 °C and +70 °C/+14 °F and 158 °F
 - Significant temperature variations
- (5) Only straight connectors are compatible with Altivar Process drives.



VW3A3628

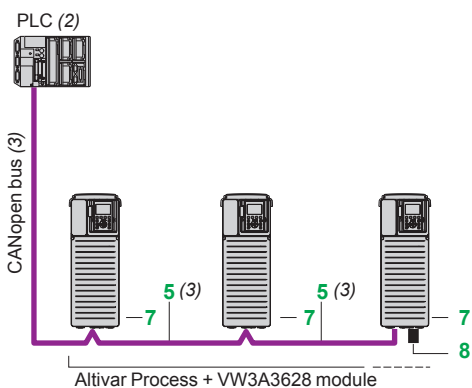

Example of connection to the CANopen bus with a screw terminal block

CANopen bus (continued) (1)

Description	Item	Length m/ ft	Unit reference	Weight kg/ lb
Communication module				
CANopen module Port: 1 x 5-way screw terminal block	7	–	VW3A3628	–
Connection to screw terminal block				
CANopen IP 20 cordsets (3) equipped with 2 x 9-way female SUB-D connectors	5	0.3/ 0.98	TSXCANCADD03	0.091/ 0.201
Standard cable, C€ mark. Low smoke zero halogen Flame-retardant (IEC 60332-1)		1/ 3.28	TSXCANCADD1	0.143/ 0.315
		3/ 9.84	TSXCANCBDD3	0.268/ 0.591
		5/ 16.40	TSXCANCBDD5	0.400/ 0.882
IP 20 CANopen tap junction boxes equipped with: ■ 4 x 9-way male SUB-D connectors + screw terminal block for trunk cable tap link ■ Line terminator	–	–	TSXCANTDM4	0.196/ 0.432
IP 20 CANopen tap junction boxes equipped with: ■ 2 screw terminal blocks for trunk cable tap link ■ 2 RJ45 connectors for connecting drives ■ 1 RJ45 connector for connecting a PC	–	–	VW3CANTAP2	–
CANopen line terminator for screw terminal connector (4)	8	–	TCSCAR01NM120	–

(1) Altivar Process drives can only take one communication module.

(2) Please refer to the "Modicon automation platform" catalogs on our website www.schneider-electric.com.

(3) Cable depends on the PLC.

(4) Sold in lots of 2.

Variable speed drives

Altivar Process

Communication buses and networks

Option: Communication modules

PF 514350

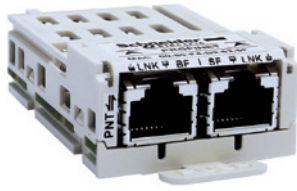

VW3A3627

PROFINET bus (1) (2)

Description	Reference	Weight kg/ lb
Communication module		
PROFINET module equipped with 2 RJ45 connectors	VW3A3627	0.290/ 0.639

PF095130



VW3A3607

PROFIBUS DP V1 bus (1) (3)

Description	Reference	Weight kg/ lb
Communication module		
PROFIBUS DP V1 module Port: 1 x 9-way female SUB-D connector Conforming to PROFIBUS DP V1 Profiles supported: ■ CiA 402 drive ■ Profidrive Offers several message handling modes based on DP V1	VW3A3607	0.140/ 0.309

SUB-D connection

IP 20 straight connectors (4) for Profibus module	LU9AD7	–
--	---------------	---

(1) Altivar Process drives can only take one communication module.
 (2) Minimum version compatible with Altivar Process: v1.2.06.
 (3) Minimum version compatible with Altivar Process: v1.9.01.
 (4) Only straight connectors are compatible with Altivar Process drives.

Variable speed drives

Altivar Process

Communication buses and networks

Option: Communication modules

PF514346

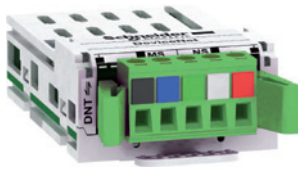

VW3A3609

DeviceNet bus (1) (2)

Description	Reference	Weight kg/ lb
Communication module		
DeviceNet module	VW3A3609	0.300/ 0.661
Port: 1 removable 5-way screw connector		
Profiles supported:		
■ CIP AC DRIVE		
■ CiA 402 drive		

(1) Altivar Process drives can only take one communication module.

(2) Minimum version compatible with Altivar Process: v1.5.05.

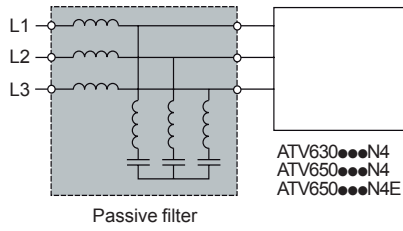

Presentation

Passive filters are used to obtain total harmonic distortion of less than 10% or 5%. Reactive power increases at no load or low load. To help reduce this reactive power, the filter capacitors can be disconnected (see the diagrams on our website www.schneider-electric.com). Passive filters provide IP 20 protection.

Applications

Reduction of current harmonics in order to use drives in the first environment (restricted distribution, domestic applications, sale conditional on the competence of the user and the distributor in terms of reducing current harmonics).



VW3A46106

Passive filters: 400 V 50 Hz three-phase supply							
Motor rating		For Altivar Process drives	Filter		Quantity required per drive	Reference (1)	Weight
kW	HP		Nominal current input	Nominal current output			
THDI < 10%			A	A			kg/lb
0.75	1	ATV630U07N4 ATV650U07N4 ATV650U07N4E	6	6.2	1	VW3A46101	12.000/ 26.455
1.5	2	ATV630U15N4 ATV650U15N4 ATV650U15N4E					
2.2	3	ATV630U22N4 ATV650U22N4 ATV650U22N4E					
3	–	ATV630U30N4 ATV650U30N4 ATV650U30N4E					
4	5	ATV630U40N4 ATV650U40N4 ATV650U40N4E	10	10.4	1	VW3A46102	13.500/ 29.762
5.5	7.5	ATV630U55N4 ATV650U55N4 ATV650U55N4E					
7.5	10	ATV630U75N4 ATV650U75N4 ATV650U75N4E	14	14.5	1	VW3A46103	16.300/ 35.935
11	15	ATV630D11N4 ATV650D11N4 ATV650D11N4E	22	23	1	VW3A46104	22.000/ 48.502
15	20	ATV630D15N4 ATV650D15N4 ATV650D15N4E	29	30	1	VW3A46105	25.000/ 55.116
18.5	25	ATV630D18N4 ATV650D18N4 ATV650D18N4E	35	37	1	VW3A46106	37.000/ 81.571
22	30	ATV630D22N4 ATV650D22N4 ATV650D22N4E	43	45	1	VW3A46107	39.000/ 85.980
30	40	ATV630D30N4 ATV650D30N4 ATV650D30N4E	58	60	1	VW3A46108	44.000/ 97.003
37	50	ATV630D37N4 ATV650D37N4 ATV650D37N4E	72	75	1	VW3A46109	56.000/ 123.459
45	60	ATV630D45N4 ATV650D45N4 ATV650D45N4E	86	90	1	VW3A46110	62.000/ 136.686
55	75	ATV630D55N4 ATV650D55N4 ATV650D55N4E	101	105	1	VW3A46111	74.000/ 163.142
75	100	ATV630D75N4 ATV650D75N4 ATV650D75N4E	144	150	1	VW3A46112	85.000/ 187.393
90	125	ATV630D90N4 ATV650D90N4 ATV650D90N4E	180	187	1	VW3A46113	102.000/ 224.871
110	150	ATV630C11N4	217	225	1	VW3A46114	119.000/ 262.350
132	200	ATV630C13N4	252	262	1	VW3A46115	136.000/ 299.828
160	250	ATV630C16N4	304	316	1	VW3A46116	142.000/ 313.056
220	350	ATV630C22N4	380	395	1	VW3A46118	172.000/ 379.195
250	400	ATV630C25N4	433	450	1	VW3A46119	205.000/ 451.947
315	500	ATV630C31N4	304	316	2	VW3A46116	142.000/ 313.056

(1) When used with ATV650U07N4/N4E...D90N4/N4E drives, the filter must be mounted in a separate enclosure to maintain IP 55 protection for the installation.

Variable speed drives

Altivar Process

Option: Passive filters

Passive filters: 400 V 50 Hz three-phase supply							
Motor rating		For Altivar Process drives	Filter		Quantity required per drive	Reference (1)	Weight
kW	HP		Nominal current input	Nominal current output			
			A	A			kg/ lb
THDI < 5%							
0.75	1	ATV630U07N4 ATV650U07N4 ATV650U07N4E	6	6.2	1	VW3A46120	16.000/ 35.274
1.5	2	ATV630U15N4 ATV650U15N4 ATV650U15N4E					
2.2	3	ATV630U22N4 ATV650U22N4 ATV650U22N4E					
3	–	ATV630U30N4 ATV650U30N4 ATV650U30N4E					
4	5	ATV630U40N4 ATV650U40N4 ATV650U40N4E	10	10.4	1	VW3A46121	18.000/ 39.683
5.5	7.5	ATV630U55N4 ATV650U55N4 ATV650U55N4E					
7.5	10	ATV630U75N4 ATV650U75N4 ATV650U75N4E	14	14.5	1	VW3A46122	20.000/ 44.092
11	15	ATV630D11N4 ATV650D11N4 ATV650D11N4E	22	23	1	VW3A46123	30.000/ 66.139
15	20	ATV630D15N4 ATV650D15N4 ATV650D15N4E	29	30	1	VW3A46124	34.000/ 74.957
18.5	25	ATV630D18N4 ATV650D18N4 ATV650D18N4E	35	37	1	VW3A46125	53.000/ 116.845
22	30	ATV630D22N4 ATV650D22N4 ATV650D22N4E	43	45	1	VW3A46126	58.000/ 127.868
30	40	ATV630D30N4 ATV650D30N4 ATV650D30N4E	58	60	1	VW3A46127	76.000/ 167.551
37	50	ATV630D37N4 ATV650D37N4 ATV650D37N4E	72	75	1	VW3A46128	98.000/ 216.053
45	60	ATV630D45N4 ATV650D45N4 ATV650D45N4E	86	90	1	VW3A46129	104.000/ 229.281
55	75	ATV630D55N4 ATV650D55N4 ATV650D55N4E	101	105	1	VW3A46130	106.000/ 233.690
75	100	ATV630D75N4 ATV650D75N4 ATV650D75N4E	144	150	1	VW3A46131	126.000/ 277.782
90	125	ATV630D90N4 ATV650D90N4 ATV650D90N4E	180	187	1	VW3A46132	135.000/ 297.623
110	150	ATV630C11N4	217	225	1	VW3A46133	172.000/ 379.195
132	200	ATV630C13N4	252	262	1	VW3A46134	206.000/ 454.152
160	250	ATV630C16N4	304	316	1	VW3A46135	221.000/ 487.221
220	350	ATV630C22N4	380	395	1	VW3A46137	265.000/ 584.225
250	400	ATV630C25N4	433	450	1	VW3A46138	272.000/ 599.657
315	500	ATV630C31N4	304	316	2	VW3A46135	221.000/ 487.221

(1) When used with ATV650U07N4/N4E...D90N4/N4E drives, the filter must be mounted in a separate enclosure to maintain IP 55 protection for the installation.

Passive filters: 460 V 60 Hz three-phase supply							
Motor rating		For Altivar Process drives	Filter		Quantity required per drive	Reference (1)	Weight
kW	HP		Nominal current				
			input	output			
THDI < 10%			A	A			kg/ lb
0.75	1	ATV630U07N4 ATV650U07N4 ATV650U07N4E	6	6.2	1	VW3A46139	12.000/ 26.455
1.5	2	ATV630U15N4 ATV650U15N4 ATV650U15N4E					
2.2	3	ATV630U22N4 ATV650U22N4 ATV650U22N4E					
3	–	ATV630U30N4 ATV650U30N4 ATV650U30N4E					
4	5	ATV630U40N4 ATV650U40N4 ATV650U40N4E	10	10.4	1	VW3A46140	13.500/ 29.762
5.5	7.5	ATV630U55N4 ATV650U55N4 ATV650U55N4E					
7.5	10	ATV630U75N4 ATV650U75N4 ATV650U75N4E	14	14.5	1	VW3A46141	16.300/ 35.935
11	15	ATV630D11N4 ATV650D11N4 ATV650D11N4E	19	19.5	1	VW3A46142	22.000/ 48.502
15	20	ATV630D15N4 ATV650D15N4 ATV650D15N4E	25	26	1	VW3A46143	23.000/ 50.706
18.5	25	ATV630D18N4 ATV650D18N4 ATV650D18N4E	31	32	1	VW3A46144	33.000/ 72.752
22	30	ATV630D22N4 ATV650D22N4 ATV650D22N4E	36	37	1	VW3A46145	37.000/ 81.571
30	40	ATV630D30N4 ATV650D30N4 ATV650D30N4E	48	50	1	VW3A46146	39.000/ 85.980
37	50	ATV630D37N4 ATV650D37N4 ATV650D37N4E	60	62	1	VW3A46147	43.000/ 94.799
45	60	ATV630D45N4 ATV650D45N4 ATV650D45N4E	73	76	1	VW3A46148	55.000/ 121.254
55	75	ATV630D55N4 ATV650D55N4 ATV650D55N4E	95	99	1	VW3A46149	62.000/ 136.686
75	100	ATV630D75N4 ATV650D75N4 ATV650D75N4E	118	122	1	VW3A46150	74.000/ 163.142
90	125	ATV630D90N4 ATV650D90N4 ATV650D90N4E	154	160	1	VW3A46151	85.000/ 187.393
110	150	ATV630C11N4	183	190	1	VW3A46152	102.000/ 224.871
132	200	ATV630C13N4	231	240	1	VW3A46153	119.000/ 262.350
160	250	ATV630C16N4	291	302.5	1	VW3A46154	142.000/ 313.056
220	350	ATV630C22N4	355	369	1	VW3A46155	162.000/ 357.149
250	400	ATV630C25N4	436	450	1	VW3A46157	205.000/ 451.948
315	500	ATV630C31N4	231	240	2	VW3A46153	119.000/ 262.35

(1) When used with ATV650U07N4/N4E...D90N4/N4E drives, the filter must be mounted in a separate enclosure to maintain IP 55 protection for the installation.

Passive filters: 460 V 60 Hz three-phase supply							
Motor rating		For Altivar Process drives	Filter		Quantity required per drive	Reference (1)	Weight
kW	HP		Nominal current				
			input	output			
		A	A			kg/lb	
THDI < 5%							
0.75	1	ATV630U07N4 ATV650U07N4 ATV650U07N4E	6	6.2	1	VW3A46158	16.000/ 35.274
1.5	2	ATV630U15N4 ATV650U15N4 ATV650U15N4E					
2.2	3	ATV630U22N4 ATV650U22N4 ATV650U22N4E					
3	–	ATV630U30N4 ATV650U30N4 ATV650U30N4E					
4	5	ATV630U40N4 ATV650U40N4 ATV650U40N4E	10	10.4	1	VW3A46159	18.000/ 39.683
5.5	7.5	ATV630U55N4 ATV650U55N4 ATV650U55N4E					
7.5	10	ATV630U75N4 ATV650U75N4 ATV650U75N4E	14	14.5	1	VW3A46160	20.000/ 44.092
11	15	ATV630D11N4 ATV650D11N4 ATV650D11N4E	19	19.5	1	VW3A46161	30.000/ 66.139
15	20	ATV630D15N4 ATV650D15N4 ATV650D15N4E	25	26	1	VW3A46162	34.000/ 74.957
18.5	25	ATV630D18N4 ATV650D18N4 ATV650D18N4E	31	32	1	VW3A46163	52.000/ 114.640
22	30	ATV630D22N4 ATV650D22N4 ATV650D22N4E	36	37	1	VW3A46164	53.000/ 116.845
30	40	ATV630D30N4 ATV650D30N4 ATV650D30N4E	48	50	1	VW3A46165	57.000/ 125.663
37	50	ATV630D37N4 ATV650D37N4 ATV650D37N4E	60	62	1	VW3A46166	75.000/ 165.347
45	60	ATV630D45N4 ATV650D45N4 ATV650D45N4E	73	76	1	VW3A46167	97.000/ 213.848
55	75	ATV630D55N4 ATV650D55N4 ATV650D55N4E	95	99	1	VW3A46168	104.000/ 229.281
75	100	ATV630D75N4 ATV650D75N4 ATV650D75N4E	118	122	1	VW3A46169	106.000/ 233.690
90	125	ATV630D90N4 ATV650D90N4 ATV650D90N4E	154	160	1	VW3A46170	126.000/ 277.782
110	150	ATV630C11N4	183	190	1	VW3A46171	135.000/ 297.624
132	200	ATV630C13N4	231	240	1	VW3A46172	172.000/ 379.195
160	250	ATV630C16N4	291	316	1	VW3A46173	221.000/ 487.221
220	350	ATV630D22N4	355	369	1	VW3A46174	229.000/ 504.858
250	400	ATV630D25N4	436	450	1	VW3A46176	272.000/ 599.657
315	500	ATV630D31N4	231	240	2	VW3A46172	172.000/ 379.195

(1) When used with ATV650U07N4/N4E...D90N4/N4E drives, the filter must be mounted in a separate enclosure to maintain IP 55 protection for the installation.

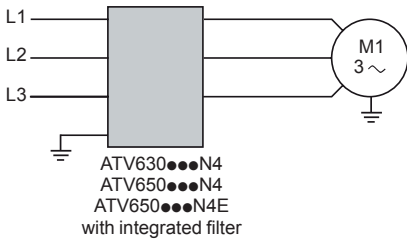

Altivar Process drive with integrated EMC filter

Integrated EMC filters

Altivar Process drives (except ATV630U07M3...D75M3) have integrated radio interference input filters in accordance with the EMC standard for variable speed electrical power drive "products" IEC/EN 61800-3, edition 2, category C2 or C3 in environment 1 or 2, and to comply with the European EMC (electromagnetic compatibility) directive.

The integrated EMC filter runs the leakage current to ground. The leakage current can be reduced by disconnecting the filter capacitors (please refer to the installation guide on our website www.schneider-electric.com). In this configuration, the product does not comply with the European EMC directive.

For drives	Maximum length of shielded cable (1) acc. to	
	IEC/EN 61800-3 category C2	IEC/EN 61800-3 category C3
	m	m
Three-phase supply voltage: 380...480 V IP 21		
ATV630U07N4... D45N4	50	150
ATV630D55N4... C16N4	-	150
ATV630C22N4... C31N4	-	50
Three-phase supply voltage: 380...480 V IP 55		
ATV650U07N4/N4E...D45N4/N4E	50	150
ATV650D55N4/N4E...D90N4/N4E	-	150

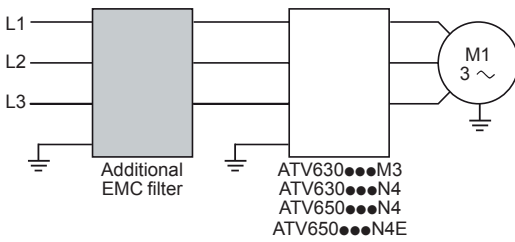

Altivar Process drive with additional EMC filter

Additional EMC input filters

Additional EMC input filters can be used to meet more stringent requirements and are designed to reduce conducted emissions on the line supply below the limits of standard IEC/EN 61800-3 category C1, C2 or C3.

Use according to the type of line supply

Use of these additional filters is only possible on TN (neutral connection) and TT (grounded neutral) type systems.

Standard IEC/EN 61800-3, appendix D2.1, states that on IT systems (isolated or impedance grounded neutral), filters can cause permanent insulation monitors to operate in a random manner.

If a machine needs to be installed on an IT system, one solution is to insert an isolation transformer and connect the machine locally to a TN or TT system.

(1) The maximum lengths are given as examples only, as they vary depending on the stray capacitance of the motors and the cables used. If motors are connected in parallel, it is the total length of all cables that should be taken into account.

Additional EMC input filters (continued)								
References								
For drives	Maximum length of shielded cable (1)			In (2)	If	Degree of Protection	Reference	Weight
	IEC/EN 61800-3 category C1 (3)	IEC/EN 61800-3 category C2 (3)	IEC/EN 61800-3 category C3 (3)					
	m	m	m	A	mA	IP		kg/ lb
Three-phase supply voltage: 200...240 V 50 Hz								
ATV630U07M3...U15M3	50	150	300	8	7.6	20	VW3A4701	2.000/ 4.409
ATV630U22M3...U30M3	50	150	300	15	7.6	20	VW3A4702	2.400/ 5.291
ATV630U40M3...U75M3	50	150	300	35	7.6	20	VW3A4703	4.100/ 9.039
ATV630D11M3	50	150	300	50	7.6	20	VW3A4704	5.200/ 11.464
ATV630D15M3	50	150	300	70	13.9	20	VW3A4705	6.100/ 13.448
ATV630D18M3...D22M3	50	150	300	100	13.9	20	VW3A4706	6.500/ 14.330
ATV630D30M3...D37M3	50	150	300	160	13.9	20	VW3A4707	8.500/ 18.739
ATV630D45M3	50	150	300	200	13.9	20	VW3A4708	9.500/ 20.944
ATV630D55M3	50	150	300	240	27.8	00	VW3A4709	15.000/ 33.069
ATV630D75M3	50	150	300	305	27.8	00	VW3A4710	17.000/ 37.479
Three-phase supply voltage: 380...480 V 50 Hz								
ATV630U07N4...U22N4 ATV650U07N4...U22N4 ATV650U07N4E...U22N4E	50	150	300	8	7.6	20	VW3A4701	2.000/ 4.409
ATV630U30N4...U55N4 ATV650U30N4...U55N4 ATV650U30N4E...U55N4E	50	150	300	15	7.6	20	VW3A4702	2.400/ 5.291
ATV630U75N4...D15N4 ATV650U75N4...D15N4 ATV650U75N4E...D15N4E	50	150	300	35	7.6	20	VW3A4703	4.100/ 9.039
ATV630D18N4...D22N4 ATV650D18N4...D22N4 ATV650D18N4E...D22N4E	50	150	300	50	7.6	20	VW3A4704	5.200/ 11.464
ATV630D30N4 ATV650D30N4 ATV650D30N4E	50	150	300	70	13.9	20	VW3A4705	6.100/ 13.448
ATV630D37N4...D45N4 ATV650D37N4...D45N4 ATV650D37N4E...D45N4E	50	150	300	100	13.9	20	VW3A4706	6.500/ 14.330
ATV630D55N4 ATV650D55N4 ATV650D55N4E	–	150	300	160	13.9	20	VW3A4707	8.500/ 18.739
ATV630D75N4...D90N4 ATV650D75N4...D90N4 ATV650D75N4E...D90N4E	–	150	300	200	13.9	20	VW3A4708	9.500/ 20.944
ATV630C11N4...C13N4	–	150	300	240	27.8	00	VW3A4709	15.000/ 33.069
ATV630C16N4	–	150	300	305	27.8	00	VW3A4710	17.000/ 37.479
ATV630C22N4...C31N4	50	300	–	546	500	00	VW3A4411	25.000/ 57.320

(1) The maximum lengths are given as examples only, as they vary depending on the stray capacitance of the motors and the cables used. If motors are connected in parallel, it is the total length of all cables that should be taken into account.

(2) Nominal filter current.

(3) Values given depend on the nominal switching frequency of the drive. This frequency depends on the drive rating.

IP 21 protection kit for IP 20 filters

Additional input filters provide IP 20 protection as standard. This kit can be used to provide IP 21 or UL type 1 protection.

Description	For filters	Reference	Weight kg/ lb
Mechanical kit including cover and cable clamps	VW3A4701	VW3A47901	0.200/ 0.441
	VW3A4702	VW3A47902	0.300/ 0.661
	VW3A4703	VW3A47903	0.400/ 0.882
	VW3A4704	VW3A47904	0.500/ 1.102
	VW3A4705	VW3A47905	0.900/ 1.984
	VW3A4706	VW3A47906	1.000/ 2.205
	VW3A4707	VW3A47907	1.500/ 3.307
	VW3A4708	VW3A47908	2.000/ 4.409

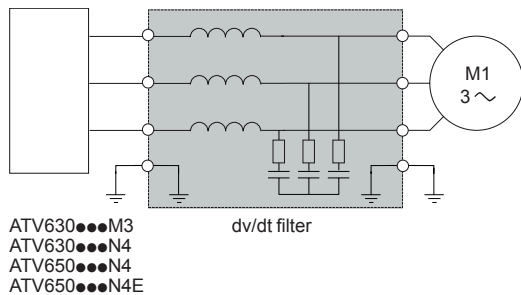

Altivar Process drive with dv/dt filter

Presentation

Altivar Process drives operate with the following maximum motor cable lengths: 150 m/492 ft for shielded cables and 300 m/984 ft for unshielded cables.

To limit the impact of dv/dt and overvoltages in the motor, it is recommended, for cables longer than 50 m/164 ft, that you check the motor insulation type and add an output filter if necessary.

For further information, please consult the “An Improved Approach for Connecting VSD and Electric Motors” White Paper available on our website www.schneider-electric.com.

Output filters are used to limit dv/dt at the motor terminals to 500 V/μs maximum.

Output filters are designed to limit overvoltages at the motor terminals to less than:

- 800 V with a shielded cable 0 to 50 m (0 to 164 ft) long, with a 400 V supply voltage
- 1,000 V with a shielded cable 50 to 150 m (164 to 492 ft) long, with a 400 V supply voltage
- 1,500 V with a shielded cable 150 to 300 m (492 to 984 ft) long, with a 400 V supply voltage (up to 500 m (1,640 ft) with an unshielded cable)

They are also used to:

- Limit overvoltages at the motor terminals
- Filter interference caused by opening a contactor placed between the filter and the motor

The performance of dv/dt filters will be affected if the maximum cable lengths are exceeded. For an application with several motors connected in parallel, the cable length must include all cabling. If a cable longer than that recommended is used, the dv/dt filters may overheat.

The switching frequency must be less than 100 Hz.

dv/dt output filters

For drives	Maximum length of motor cable		Degree of protection (3)	In	Reference	Weight
	Maximum switching frequency (1)	Shielded cable frequency (2)				
	kHz	m/ft	IP	A		kg/lb
Three-phase supply voltage: 200...240 V						
ATV630U07M3	4	300/ 984	20	6	VW3A5301	11.000/ 24.251
ATV630U15M3...U30M3	4	300/ 984	20	15	VW3A5302	12.000/ 26.455
ATV630U40M3	4	300/ 984	20	25	VW3A5303	12.000/ 26.455
ATV630U55M3...D11M3	4	300/ 984	20	50	VW3A5304	18.000/ 39.683
ATV630D15M3...D22M3	4	300/ 984	20	95	VW3A5305	19.000/ 41.888
ATV630D30M3...D45M3	2.5	300/ 984	00	180	VW3A5306	22.000/ 48.502
ATV630D55M3...D75M3	2.5	300/ 984	00	305	VW3A5307	40.000/ 88.185

(1) The filters are designed to operate in a switching frequency range of between 2 and 8 kHz.

(2) Values given depend on the nominal switching frequency of the drive. This frequency depends on the drive rating. These cable lengths are given as examples only as they can vary depending on the application. They correspond to motors conforming to IEC 6034-25 and NEMA MG1/31.2006.

(3) Nominal filter current.

Variable speed drives

Altivar Process: Output filters

Option: dv/dt filters

dv/dt output filters (continued)						
For drives	Maximum length of motor cable		Degree of protection	In (3)	Reference (4)	Weight
	Maximum switching frequency (1)	Shielded cable (2)				
	kHz	m/ft	IP	A		kg/lb
Three-phase supply voltage: 380...480 V						
ATV630U07N4...U22N4 ATV650U07N4...U22N4 ATV650U07N4E...U22N4E	4	300/ 984	20	6	VW3A5301	11.000/ 24.251
ATV630U30N4...U55N4 ATV650U30N4...U55N4 ATV650U30N4E...U55N4E	4	300/ 984	20	15	VW3A5302	12.000/ 26.455
ATV630U75N4...D11N4 ATV650U75N4...D11N4 ATV650U75N4E...D11N4E	4	300/ 984	20	25	VW3A5303	12.000/ 26.455
ATV630D15N4...D22N4 ATV650D15N4...D22N4 ATV650D15N4E...D22N4E	4	300/ 984	20	50	VW3A5304	18.000/ 39.683
ATV630D30N4...D45N4 ATV650D30N4...D45N4 ATV650D30N4E...D45N4E	4	300/ 984	20	95	VW3A5305	19.000/ 41.888
ATV630D55N4...D90N4 ATV650D55N4...D90N4 ATV650D55N4E...D90N4E	2.5	300/ 984	00	180	VW3A5306	22.000/ 48.502
ATV630C11N4...C16N4	2.5	300/ 984	00	305	VW3A5307	40.000/ 88.185
ATV630C22N4	2.5	250/ 820	00	481	VW3A5106	58.000/ 127.868
ATV630C25N4...C31N4	2.5	200/ 656	00	759	VW3A5107	93.000/ 205.230

IP 20 protection kit for IP 00 filters

Description	For dv/dt filters	Reference	Weight kg/lb
Mechanical kit including cover and cable clamps	VW3A5106 VW3A5107	VW3A9613	-

IP 21 protection kit for IP 20 filters

Description	For dv/dt filters	Reference	Weight kg/lb
Mechanical kit including cover and cable clamps	VW3A5301 VW3A5302 VW3A5303	VW3A53902	1.300/ 2.866
	VW3A5304	VW3A53903	1.700/ 3.748
	VW3A5305	VW3A53905	3.200/ 7.055

(1) The filters are designed to operate in a switching frequency range of between 2 and 8 kHz.

(2) Values given depend on the nominal switching frequency of the drive. This frequency depends on the drive rating. These cable lengths are given as examples only as they can vary depending on the application. They correspond to motors conforming to IEC 6034-25 and NEMA MG1/31.2006.

(3) Nominal filter current.

(4) When used with **ATV650U07N4/N4E...D90N4/N4E** drives, the filter must be mounted in a separate enclosure to maintain IP 55 protection for the installation.

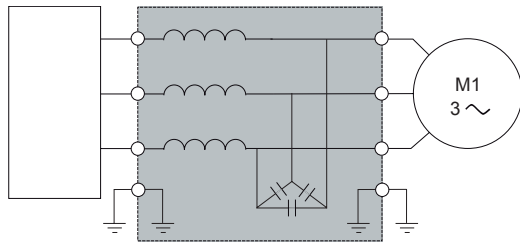

ATV630●●●M3
ATV630●●●N4
ATV650●●●N4
ATV650●●●N4E

Sinus filter

Altivar Process drive with sinus filter

Presentation

Sinus filters allow Altivar Process drives to operate with long motor cables:

- 500 m (1,640 ft) with a shielded cable
- 1,000 m (3,280 ft) with an unshielded cable

The minimum switching frequency at which sinus filters can operate is 4 kHz. This is the default value when the sinus filter function is activated on the variable speed drive (please refer to the programming guide on our website www.schneider-electric.com).

The output frequency must be less than 100 Hz.

At 100% load, the voltage drop is less than 8% with output frequency 50 Hz and switching frequency 4 kHz.

Applications

For applications requiring:

- Long cable runs
- Motors connected in parallel
- Submersible pumps sensitive to dv/dt
- An intermediate transformer between the drive and the motor

Sinus filters

For drives	Nominal current	Degree of protection	Reference (1)	Weight
	A	IP		kg/ lb
Three-phase supply voltage: 200...240 V				
ATV630U07M3	6	20	VW3A5401	10.000/ 22.046
ATV630U15M3...U30M3	15	20	VW3A5402	13.500/ 29.762
ATV630U40M3	25	20	VW3A5403	20.000/ 44.092
ATV630U55M3...D11M3	50	20	VW3A5404	35.000/ 77.162
ATV630D15M3...D22M3	95	20	VW3A5405	60.000/ 132.277
ATV630D30M3...D45M3	180	00	VW3A5406	90.000/ 198.416
ATV630D75M3 (2)	305	00	VW3A5407	134.000/ 295.419

(1) The filters are designed to operate in a switching frequency range of between 4 and 8 kHz.

(2) In "Normal Duty", apply a derating of 1 to the drive nominal power with a minimum switching frequency of 4 kHz.

For example: An ATV630D75M3 drive with sinus filter can be used on a 55 kW motor.

Variable speed drives

Altivar Process: Output filters

Option: Sinus filters

Sinus filters (continued)				
For drives	Nominal current	Degree of protection	Reference (1) (2)	Weight
	A	IP		kg/ lb
Three-phase supply voltage: 380...480 V				
ATV630U07N4...U22N4 ATV650U07N4...U22N4 ATV650U07N4E...U22N4E	6	20	VW3A5401	10.000/ 22.046
ATV630U30N4...U55N4 ATV650U30N4...U55N4 ATV650U30N4E...U55N4E	15	20	VW3A5402	13.500/ 29.762
ATV630U75N4...D11N4 ATV650U75N4...D11N4 ATV650U75N4E...D11N4E	25	20	VW3A5403	20.000/ 44.092
ATV630D15N4...D22N4 ATV650D15N4...D22N4 ATV650D15N4E...D22N4E	50	20	VW3A5404	35.000/ 77.162
ATV630D30N4...D45N4 ATV650D30N4...D45N4 ATV650D30N4E...D45N4E	95	20	VW3A5405	60.000/ 132.277
ATV630D55N4...D90N4 ATV650D55N4...D90N4 ATV650D55N4E...D90N4E	180	00	VW3A5406	90.000/ 198.416
ATV630C13N4...C16N4 (3)	305	00	VW3A5407	134.000/ 295.419
ATV630C22N4	400	00	VW3A5209	190.000/ 418.878
ATV630C25N4..C31N4	600	00	VW3A5210	260.000/ 573.202

IP 21 protection kit for IP 20 filters

Description	For sinus filter	Reference	Weight kg/ lb
Mechanical kit including cover and cable clamps	VW3A5401 VW3A5402	VW3A53901	1.000/ 2.205
	VW3A5403	VW3A53902	1.300/ 2.866
	VW3A5404	VW3A53903	2.700/ 5.952
	VW3A5405	VW3A53904	3.200/ 7.055

- (1) The filters are designed to operate in a switching frequency range of between 4 and 8 kHz.
(2) When used with **ATV650U07N4/N4E...D90N4/N4E** drives, the filter must be mounted in a separate enclosure to maintain IP 55 protection for the installation.
(3) In "Normal Duty", apply a derating of 1 to the drive nominal power with a minimum switching frequency of 4 kHz. For example:
An ATV630C13N4 drive with sinus filter can be used on a 110 kW motor.
An ATV630C16N4 drive with sinus filter can be used on a 132 kW motor.

Variable speed drives

Altivar Process: Output filters

Option: Common mode filters

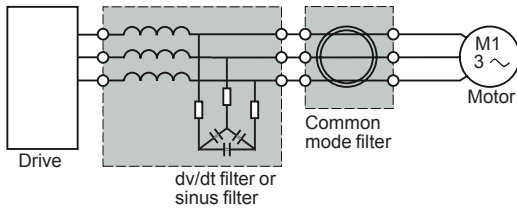

Altivar Process ATV600 drive with common mode filter

Presentation

Sinus filters or dv/dt filters reduce the overvoltage across windings and high frequency currents in differential mode. But they have no effect on the common mode current between phases and the cable shielding, and between the windings and the stator/rotor of the motor.

Common mode filters bring several benefits:

- Reduction of RFI (radio frequency interference) of the motor cable and improvement of the effectiveness of the EMC filter for conducted emissions
- Reduction of the high frequency currents circulating in the bearings of the motor and protection of the bearings (to help prevent damage).

It is possible to use the common mode filter at the output terminals of the drive, the dv/dt filter, or the sinus filter.

Note: The selection of a common mode configuration depends on the type and length of motor cable. An abnormal increase of the temperature indicates a possible saturation. Additional filters shall be used to avoid it.

Common mode filters

For drives	Maximum length of unshielded cable			
	150 m/ 492.12 ft	300 m/ 984.25 ft	500 m/ 1,640.42 ft	1,000 m/ 3,280.83 ft
ATV630U07M3...U40M3	VW3A5501	VW3A5502	2 x VW3A5501	VW3A5501 + VW3A5502
ATV630U55M3	VW3A5501	VW3A5502	VW3A5501 + VW3A5502	2 x VW3A5502
ATV630U75M3...D11M3	VW3A5503	VW3A5504	2 x VW3A5503	VW3A5503 + VW3A5504
ATV630D15M3...D45M3	VW3A5503	VW3A5504	VW3A5503 + VW3A5504	2 x VW3A5504
ATV630D55M3...D75M3	VW3A5505	VW3A5506	2 x VW3A5505	2 x VW3A5506

Variable speed drives

Altivar Process: Output filters

Option: Common mode filters

Common mode filters (continued)

For drives	Maximum length of unshielded cable			
	150 m/ 492.12 ft	300 m/ 984.25 ft	500 m/ 1,640.42 ft	1,000 m/ 3,280.83 ft
ATV630U07N4...U40N4 ATV650U07N4...U40N4 ATV650U07N4E...U40N4E	VW3A5501	VW3A5502	2 x VW3A5501	VW3A5501 + VW3A5502
ATV630U55N4 ATV650U55N4 ATV650U55N4E	VW3A5501	VW3A5502	VW3A5501 + VW3A5502	VW3A5501 + VW3A5502
ATV630U75N4...D11N4 ATV650U75N4...D11N4 ATV650U75N4E...D11N4E	VW3A5501	VW3A5502	VW3A5501 + VW3A5502	2 x VW3A5502
ATV630D15N4...D22N4 ATV650D15N4...D22N4 ATV650D15N4E...D22N4E	VW3A5503	VW3A5504	2 x VW3A5503	VW3A5503 + VW3A5504
ATV630D30N4...D90N4 ATV650D30N4...D90N4 ATV650D30N4E...D90N4E	VW3A5503	VW3A5504	VW3A5503 + VW3A5504	2 x VW3A5504
ATV630C11N4...C16N4	VW3A5505	VW3A5506	2 x VW3A5505	2 x VW3A5506

For drives	Maximum length of shielded cable		
	150 m/ 492.12 ft	300 m/ 984.25 ft	500 m/ 1,640.42 ft
ATV630U07N4...U40N4 ATV650U07N4...U40N4 ATV650U07N4E...U40N4E	VW3A5501	VW3A5502	2 x VW3A5501
ATV630U55N4 ATV650U55N4 ATV650U55N4E	VW3A5502	2 x VW3A5501	2 x VW3A5502
ATV630U75N4...D11N4 ATV650U75N4...D11N4 ATV650U75N4E...D11N4E	VW3A5502	2 x VW3A5501	2 x VW3A5502
ATV630D15N4...D22N4 ATV650D15N4...D22N4 ATV650D15N4E...D22N4E	VW3A5503	2 x VW3A5503	VW3A5503 + VW3A5504
ATV630D30N4...D90N4 ATV650D30N4...D90N4 ATV650D30N4E...D90N4E	VW3A5504	VW3A5503 + VW3A5504	2 x VW3A5504
ATV630C11N4	VW3A5505	VW3A5506	VW3A5505 + VW3A5506
ATV630C13N4...C16N4	VW3A5506	2 x VW3A5505	2 x VW3A5506

Applications

Circuit breaker/contactor/drive combinations help to ensure continuity of service in the installation.

The type of circuit breaker/contactor coordination selected can reduce maintenance costs in the event of a motor short-circuit on the drive input by minimizing the time required to make the necessary repairs and the cost of replacement equipment. The suggested combinations provide coordination according to the drive rating.

The drive controls the motor, provides a monitoring function against short-circuits between the drive and the motor, and helps protect the motor cable against overloads. Overload monitoring is provided by the drive's motor thermal monitoring function if this has been enabled. Otherwise, an external monitoring device such as a probe or thermal overload relay should be provided.

The circuit breaker helps protect the drive's power cables against short-circuits.



GV3L40

+



LC1D40A●●

+



ATV630D11M3

IEC standard motor starters

Motor Power (1)	Drive Reference	Circuit breaker Reference (2)	Rating	I _{rm}	Line contactor Reference (3) (4)	
kW	HP		A	A		
Three-phase supply voltage: 200...240 V 50/60 Hz						
0.75	1	ATV630U07M3	GV2L08	4	51	LC1D09●●
1.5	2	ATV630U15M3	GV2L10	6.3	78	LC1D09●●
2.2	3	ATV630U22M3	GV2L14	10	138	LC1D09●●
3	–	ATV630U30M3	GV2L16	14	170	LC1D18●●
4	5	ATV630U40M3	GV2L20	18	223	LC1D18●●
5.5	7.5	ATV630U55M3	GV2L22	25	327	LC1D25●●
7.5	10	ATV630U75M3	GV2L32	32	448	LC1D40A●●
11	15	ATV630D11M3	GV3L40	40	560	LC1D40A●●
15	20	ATV630D15M3	GV3L65	65	910	LC1D65A●●
18.5	25	ATV630D18M3	NS80HMA	80	1,000	LC1D65A●●
22	30	ATV630D22M3	NS80HMA	80	1,000	LC1D80●●
30	40	ATV630D30M3	NSX100●MA100	100	1,300	LC1D95●●
37	50	ATV630D37M3	NSX160●MA150	150	1,500	LC1D115●●
45	60	ATV630D45M3	NSX160●MA150	150	1,500	LC1D150●●
55	75	ATV630D55M3	NSX250●MA220	220	2,420	LC1F185●●
75	100	ATV630D75M3	NSX400● Micrologic 1.3-M	320	3,500	LC1F265●●

(1) Standard power ratings for 230 V 50/60 Hz 4-pole motors.

The values expressed in HP conform to the NEC (National Electrical Code).

(2) For references to be completed, replace the dot with the letter corresponding to the breaking performance of the circuit breaker (F, N, H, S, or L).

Breaking capacity of circuit breakers according to standard IEC 60947-2:

Circuit breaker	I _{cu} (kA) for 200...240 V	I _{cu} (kA) for 200...240 V				
		F	N	H	S	L
GV2L08...16	130	–	–	–	–	–
GV2L20...32	130	–	–	–	–	–
GV3L40...65	50	–	–	–	–	–
NS80HMA	100	–	–	–	–	–
NSX100●MA100	–	85	90	100	120	150
NSX160●MA150	–	85	90	100	120	150
NSX250●MA220	–	85	90	100	120	150
NSX400● Micrologic 1.3-M	–	40	85	100	120	150

(3) Composition of contactors:

LC1D09...D150: 3 poles + 1 NO auxiliary contact + 1 NC auxiliary contact

LC1F185...F265: 3 poles

To add auxiliary contacts or other accessories, please refer to the "Motor-starter solutions - Control and protection components" catalog.

(4) Replace ●● with the control circuit voltage code indicated in the table below:

	Volts ~	24	48	110	220	230	240
LC1D09...D150	50 Hz	B5	E5	F5	M5	P5	U5
	60 Hz	B6	E6	F6	M6	–	U6
	50/60 Hz	B7	E7	F7	M7	P7	U7
LC1F185	50 Hz (LX1 coil)	B5	E5	F5	M5	P5	U5
	60 Hz (LX1 coil)	–	E6	F6	M6	–	U6
	40...400 Hz (LX9 coil)	–	E7	F7	M7	P7	U7
LC1F265	40...400 Hz (LX1 coil)	B7	E7	F7	M7	P7	U7

For other voltages available between 24 V and 660 V, or a DC control circuit, please contact our Customer Care Center.



NSX100FMA100

+



LC1D80●●

+



ATV630D45N4

IEC standard motor starters

Motor	Drive	Circuit breaker		Line contactor		
Power (1)	Reference	Reference (2)	Rating	I _{rm}	Reference (4) (5)	
kW	HP		A	A		
Three-phase supply voltage: 380...415 V 50/60 Hz						
0.75	1	ATV630U07N4	GV2L07	2.5	33.5	LC1D09●●
1.5	2	ATV630U15N4	GV2L08	4	51	LC1D09●●
2.2	3	ATV630U22N4	GV2L10	6.3	78	LC1D09●●
3	–	ATV630U30N4	GV2L14	10	138	LC1D09●●
4	5	ATV630U40N4	GV2L14	10	138	LC1D09●●
5.5	7.5	ATV630U55N4	GV2L16	14	170	LC1D18●●
7.5	10	ATV630U75N4	GV2L20	18	223	LC1D18●●
11	15	ATV630D11N4	GV2L22	25	327	LC1D25●●
15	20	ATV630D15N4	GV3L32	32	448	LC1D25●●
18.5	25	ATV630D18N4	GV3L40	40	560	LC1D40A●●
22	30	ATV630D22N4	GV3L50	50	700	LC1D50A●●
30	40	ATV630D30N4	GV3L65	65	910	LC1D50A●●
37	50	ATV630D37N4	NS80HMA	80	1,000	LC1D65A●●
45	60	ATV630D45N4	NSX100●MA100	100	1,300	LC1D80●●
55	75	ATV630D55N4	NSX160●MA150	150	1,500	LC1D115●●
75	100	ATV630D75N4	NSX160●MA150	150	1,500	LC1D115●●
90	125	ATV630D90N4	NSX250●MA220	220	2,420	LC1F185●●
110	150	ATV630C11N4	NSX250●MA220	220	2,860	LC1F185●●
132	200	ATV630C13N4	NSX400● Micrologic 1.3-M	320	3,500	LC1F265●●
160	250	ATV630C16N4	NSX400● Micrologic 1.3-M	320	4,000	LC1F265●●
220	350	ATV630C22N4	NSX630● Micrologic 1.3-M	500	3,000	LC1F400●●
250	400	ATV630C25N4	NSX630● Micrologic 1.3-M	500	3,000	LC1F500●●
310	500	ATV630C31N4	NS800L Micrologic 2 or 5	800	1,600	LC1F630●●

(1) Standard power ratings for 400 V 50/60 Hz 4-pole motors.

The values expressed in HP conform to the NEC (National Electrical Code).

(2) For references to be completed, replace the dot with the letter corresponding to the breaking performance of the circuit breaker (F, N, H, S, or L).

Breaking capacity of circuit breakers according to standard IEC 60947-2:

Circuit breaker	I _{cu} (kA) for 380...415 V					
	F	N	H	S	L	
GV2L07	100	–	–	–	–	
GV2L08...14 (3)	130	–	–	–	–	
GV2L14 (3)...22	50	–	–	–	–	
GV3L32...65	50	–	–	–	–	
NS80HMA	70	–	–	–	–	
NSX100●MA100	–	36	50	70	100	150
NSX160●MA150	–	36	50	70	100	150
NSX250●MA220	–	36	50	70	100	150
NSX400●, NSX630●	–	36	50	70	100	150
NS800L Micrologic 2 or 5	–	–	–	–	–	150

(3) GV2L14: I_{cu} of 130 kA in combination with an ATV630U30N4, I_{cu} of 20 kA with an ATV630U40N4.

(4) Composition of contactors:

LC1D09...D115: 3 poles + 1 NO auxiliary contact + 1 NC auxiliary contact

LC1F185...F265: 3 poles

To add auxiliary contacts or other accessories, please refer to the "Motor-starter solutions - Control and protection components" catalog.

(5) Replace ●● with the control circuit voltage code indicated in the table below:

	Volts ~	24	48	110	220	230	240
LC1D09...D115	50 Hz	B5	E5	F5	M5	P5	U5
	60 Hz	B6	E6	F6	M6	–	U6
	50/60 Hz	B7	E7	F7	M7	P7	U7
LC1F185	50 Hz (LX1 coil)	B5	E5	F5	M5	P5	U5
	60 Hz (LX1 coil)	–	E6	F6	M6	–	U6
	40...400 Hz (LX9 coil)	–	E7	F7	M7	P7	U7
LC1F265	40...400 Hz (LX1 coil)	B7	E7	F7	M7	P7	U7
LC1F400...F800	40...400 Hz (LX1 coil)	–	E7	F7	M7	P7	U7

For other voltages available between 24 V and 660 V, or a DC control circuit, please contact our Customer Care Center.



NSX100FMA100

+



LC1D80●●

+



ATV650D45N4

IEC standard motor starters						
Motor	Drive	Circuit breaker			Line contactor	
Power (1)	Reference	Reference (2)	Rating	I _{rm}	Reference (4) (5) (6)	
kW	HP		A	A		
Three-phase supply voltage: 380...415 V 50/60 Hz						
0.75	1	ATV650U07N4/N4E	GV2L07	2.5	33.5	LC1D09●●
1.5	2	ATV650U15N4/N4E	GV2L08	4	51	LC1D09●●
2.2	3	ATV650U22N4/N4E	GV2L10	6.3	78	LC1D09●●
3	–	ATV650U30N4/N4E	GV2L14	10	138	LC1D09●●
4	5	ATV650U40N4/N4E	GV2L14	10	138	LC1D09●●
5.5	7.5	ATV650U55N4/N4E	GV2L16	14	170	LC1D18●●
7.5	10	ATV650U75N4/N4E	GV2L20	18	223	LC1D18●●
11	15	ATV650D11N4/N4E	GV2L22	25	327	LC1D25●●
15	20	ATV650D15N4/N4E	GV3L32	32	448	LC1D25●●
18.5	25	ATV650D18N4/N4E	GV3L40	40	560	LC1D40A●●
22	30	ATV650D22N4/N4E	GV3L50	50	700	LC1D50A●●
30	40	ATV650D30N4/N4E	GV3L65	65	910	LC1D50A●●
37	50	ATV650D37N4/N4E	NS80HMA	80	1,000	LC1D65A●●
45	60	ATV650D45N4/N4E	NSX100●MA100	100	1,300	LC1D80●●
55	75	ATV650D55N4/N4E	NSX160●MA150	150	1,500	LC1D115●●
75	100	ATV650D75N4/N4E	NSX160●MA150	150	1,500	LC1D115●●
90	125	ATV650D90N4/N4E	NSX250●MA220	220	2,420	LC1F185●●

(1) Standard power ratings for 400 V 50/60 Hz 4-pole motors.

The values expressed in HP conform to the NEC (National Electrical Code).

(2) For references to be completed, replace the dot with the letter corresponding to the breaking performance of the circuit breaker (F, N, H, S, or L).

Breaking capacity of circuit breakers according to standard IEC 60947-2:

Circuit breaker	I _{cu} (kA) for 380...415 V	I _{cu} (kA) for 380...415 V				
		F	N	H	S	L
GV2L07	100	–	–	–	–	–
GV2L08...14 (3)	130	–	–	–	–	–
GV2L14 (3)...22	50	–	–	–	–	–
GV3L32...65	50	–	–	–	–	–
NS80HMA	70	–	–	–	–	–
NSX100●MA100	–	36	50	70	100	150
NSX160●MA150	–	36	50	70	100	150
NSX250●MA220	–	36	50	70	100	150

(3) GV2L14: I_{cu} of 130 kA in combination with an ATV650U30N4/N4E, I_{cu} of 20 kA with an ATV650U40N4/N4E.

(4) Composition of contactors:

LC1D09...D115: 3 poles + 1 NO auxiliary contact + 1 NC auxiliary contact

LC1F185: 3 poles

To add auxiliary contacts or other accessories, please refer to the "Motor-starter solutions - Control and protection components" catalog.

(5) Replace ●● with the control circuit voltage code indicated in the table below:

	Volts ~	24	48	110	220	230	240
		LC1D09...D115	50 Hz	B5	E5	F5	M5
	60 Hz	B6	E6	F6	M6	–	U6
	50/60 Hz	B7	E7	F7	M7	P7	U7
LC1F185	50 Hz (LX1 coil)	B5	E5	F5	M5	P5	U5
	60 Hz (LX1 coil)	–	E6	F6	M6	–	U6
	40...400 Hz (LX9 coil)	–	E7	F7	M7	P7	U7

For other voltages available between 24 V and 660 V, or a DC control circuit, please contact our Customer Care Center.

(6) When they are used with ATV650U07N4/N4E...D90N4/N4E drives, the motor starters must be installed in a separate enclosure to maintain the IP 55 protection rating of the installation.



GV2L08

+



LC1D09●●

+



ATV630U15N4

IEC standard motor starters

Motor Power (1)	Drive Reference	Circuit breaker Reference (2)	Rating A	I _{rm} A	Line contactor Reference (4) (5)	
kW	HP					
Three-phase supply voltage: 440 V 50/60 Hz						
0.75	1	ATV630U07N4	GV2L07	2.5	33.5	LC1D09●●
1.5	2	ATV630U15N4	GV2L08	4	51	LC1D09●●
2.2	3	ATV630U22N4	GV2L10	6.3	78	LC1D09●●
3	–	ATV630U30N4	GV2L10	6.3	78	LC1D09●●
4	5	ATV630U40N4	GV2L14	10	138	LC1D09●●
5.5	7.5	ATV630U55N4	GV2L16	14	170	LC1D18●●
7.5	10	ATV630U75N4	GV2L16	14	170	LC1D18●●
11	15	ATV630D11N4	GV2L22	25	327	LC1D25●●
15	20	ATV630D15N4	GV3L32	32	448	LC1D25●●
18.5	25	ATV630D18N4	GV3L40	40	560	LC1D40A●●
22	30	ATV630D22N4	GV3L50	50	700	LC1D50A●●
30	40	ATV630D30N4	GV3L65	65	910	LC1D50A●●
37	50	ATV630D37N4	GV3L66	65	910	LC1D65A●●
45	60	ATV630D45N4	NS80HMA	80	1,000	LC1D80●●
55	75	ATV630D55N4	NSX100●MA100	100	1,040	LC1D95●●
75	100	ATV630D75N4	NSX160●MA150	150	1,500	LC1D115●●
90	125	ATV630D90N4	NSX250●MA220	150	1,500	LC1D115●●
110	150	ATV630C11N4	NSX250●MA220	220	2,420	LC1F185●●
132	200	ATV630C13N4	NSX400● Micrologic 1.3-M	220	2,420	LC1F185●●
160	250	ATV630C16N4	NSX400● Micrologic 1.3-M	320	3,500	LC1F265●●
220	350	ATV630C22N4	NSX630● Micrologic 1.3-M	500	3,000	LC1F400●●
250	400	ATV630C25N4	NSX630● Micrologic 1.3-M	500	3,000	LC1F500●●
310	500	ATV630C31N4	NS800L Micrologic 2 or 5	800	1,600	LC1F630●●

(1) Standard power ratings for 400 V 50/60 Hz 4-pole motors.

The values expressed in HP conform to the NEC (National Electrical Code).

(2) For references to be completed, replace the dot with the letter corresponding to the breaking performance of the circuit breaker (F, N, H, S, or L).

Breaking capacity of circuit breakers according to standard IEC 60947-2:

Circuit breaker	I _{cu} (kA) for 440 V					
	F	N	H	S	L	
GV2L07	100	–	–	–	–	
GV2L08...16 (3)	130	–	–	–	–	
GV2L16 (3)...22	20	–	–	–	–	
GV3L32...66	50	–	–	–	–	
NS80HMA	65	–	–	–	–	
NSX100●MA100	–	35	50	65	90	130
NSX160●MA150	–	35	50	65	90	130
NSX250●MA220	–	35	50	65	90	130
NSX400●, NSX630●	–	30	42	65	90	130
NS800L Micrologic 2 or 5	–	–	–	–	–	130

(3) GV2L16: I_{cu} of 130 kA in combination with an ATV630U30N4, I_{cu} of 20 kA with an ATV630U40N4.

(4) Composition of contactors:

LC1D09...D115: 3 poles + 1 NO auxiliary contact + 1 NC auxiliary contact

To add auxiliary contacts or other accessories, please refer to the "Motor-starter solutions - Control and protection components" catalog.

(5) Replace ●● with the control circuit voltage code indicated in the table below:

	Volts ~	24	48	110	220	230	240
		LC1D09...D115	50 Hz	B5	E5	F5	M5
	60 Hz	B6	E6	F6	M6	–	U6
	50/60 Hz	B7	E7	F7	M7	P7	U7
LC1F185	50 Hz (LX1 coil)	B5	E5	F5	M5	P5	U5
	60 Hz (LX1 coil)	–	E6	F6	M6	–	U6
	40...400 Hz (LX9 coil)	–	E7	F7	M7	P7	U7
LC1F265	40...400 Hz (LX1 coil)	B7	E7	F7	M7	P7	U7
LC1F400...F630	40...400 Hz (LX1 coil)	–	E7	F7	M7	P7	U7

For other voltages available between 24 V and 660 V, or a DC control circuit, please contact our Customer Care Center.



NSX250•MA220

+



LC1D115••

+



ATV650D90N4

IEC standard motor starters

Motor Power (1) kW HP	Drive Reference	Circuit breaker			Line contactor
		Reference (2)	Rating	I _{rm}	Reference (4) (5)
Three-phase supply voltage: 440 V 50/60 Hz					
0.75 1	ATV650U07N4/N4E	GV2L07	2.5	33.5	LC1D09••
1.5 2	ATV650U15N4/N4E	GV2L08	4	51	LC1D09••
2.2 3	ATV650U22N4/N4E	GV2L10	6.3	78	LC1D09••
3 –	ATV650U30N4/N4E	GV2L10	6.3	78	LC1D09••
4 5	ATV650U40N4/N4E	GV2L14	10	138	LC1D09••
5.5 7.5	ATV650U55N4/N4E	GV2L16	14	170	LC1D18••
7.5 10	ATV650U75N4/N4E	GV2L16	14	170	LC1D18••
11 15	ATV650D11N4/N4E	GV2L22	25	327	LC1D25••
15 20	ATV650D15N4/N4E	GV3L32	32	448	LC1D25••
18.5 25	ATV650D18N4/N4E	GV3L40	40	560	LC1D40A••
22 30	ATV650D22N4/N4E	GV3L50	50	700	LC1D50A••
30 40	ATV650D30N4/N4E	GV3L65	65	910	LC1D50A••
37 50	ATV650D37N4/N4E	GV3L66	65	910	LC1D65A••
45 60	ATV650D45N4/N4E	NS80HMA	80	1,000	LC1D80••
55 75	ATV650D55N4/N4E	NSX100•MA100	100	1,040	LC1D95••
75 100	ATV650D75N4/N4E	NSX160•MA150	150	1,500	LC1D115••
90 125	ATV650D90N4/N4E	NSX250•MA220	150	1,500	LC1D115••

(1) Standard power ratings for 400 V 50/60 Hz 4-pole motors.

The values expressed in HP conform to the NEC (National Electrical Code).

(2) For references to be completed, replace the dot with the letter corresponding to the breaking performance of the circuit breaker (F, N, H, S, or L).

Breaking capacity of circuit breakers according to standard IEC 60947-2:

Circuit breaker	I _{cu} (kA) for 440 V	I _{cu} (kA) for 440 V				
		F	N	H	S	L
GV2L07	100	–	–	–	–	–
GV2L08...16 (3)	130	–	–	–	–	–
GV2L16 (3)...22	20	–	–	–	–	–
GV3L32...66	50	–	–	–	–	–
NS80HMA	65	–	–	–	–	–
NSX100•MA100	–	35	50	65	90	130
NSX160•MA150	–	35	50	65	90	130
NSX250•MA220	–	35	50	65	90	130

(3) GV2L16: I_{cu} of 130 kA in combination with an ATV650U30N4/N4E, I_{cu} of 20 kA with an ATV650U40N4/N4E.

(4) Composition of contactors:

LC1D09...D115: 3 poles + 1 NO auxiliary contact + 1 NC auxiliary contact

To add auxiliary contacts or other accessories, please refer to the "Motor-starter solutions - Control and protection components" catalog.

(5) Replace •• with the control circuit voltage code indicated in the table below:

	Volts ~	24	48	110	220	230	240
LC1D09...D115	50 Hz	B5	E5	F5	M5	P5	U5
	60 Hz	B6	E6	F6	M6	–	U6
	50/60 Hz	B7	E7	F7	M7	P7	U7

For other voltages available between 24 V and 660 V, or a DC control circuit, please contact our Customer Care Center.

(6) When they are used with ATV650U07N4/N4E...D90N4/N4E drives, the motor starters must be installed in a separate enclosure to maintain the IP 55 protection rating of the installation.

Variable speed drives

Altivar Process

IP 21 drives: 200...240 V, 380...480 V

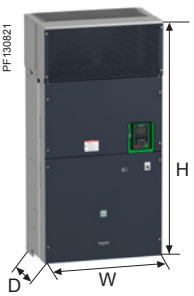

200...240 V IP 21/UL Type 1 drives

Overall dimensions

Drives	W x H x D	
	mm	in.
ATV630U07M3	144 x 350 x 203	5.67 x 13.78 x 7.99
ATV630U15M3	144 x 350 x 203	5.67 x 13.78 x 7.99
ATV630U22M3	144 x 350 x 203	5.67 x 13.78 x 7.99
ATV630U30M3	144 x 350 x 203	5.67 x 13.78 x 7.99
ATV630U40M3	144 x 350 x 203	5.67 x 13.78 x 7.99
ATV630U55M3	171 x 409 x 233	6.73 x 16.10 x 9.17
ATV630U75M3	211 x 546 x 232	8.31 x 21.50 x 9.13
ATV630D11M3	211 x 546 x 232	8.31 x 21.50 x 9.13
ATV630D15M3	226 x 673 x 271	8.90 x 26.50 x 10.67
ATV630D18M3	226 x 673 x 271	8.90 x 26.50 x 10.67
ATV630D22M3	226 x 673 x 271	8.90 x 26.50 x 10.67
ATV630D30M3	290 x 922 x 323	11.42 x 36.30 x 12.72
ATV630D37M3	290 x 922 x 323	11.42 x 36.30 x 12.72
ATV630D45M3	290 x 922 x 323	11.42 x 36.30 x 12.72
ATV630D55M3	320 x 852 x 390	12.60 x 33.54 x 15.35
With IP 21/UL Type 1 conformity kit	(1)	
ATV630D75M3	320 x 852 x 390	12.60 x 33.54 x 15.35
With IP 21/UL Type 1 conformity kit	(1)	

380...480 V IP 21/UL Type 1 drives

Overall dimensions

Drives	W x H x D	
	mm	in.
ATV630U07N4	144 x 350 x 203	5.67 x 13.78 x 7.99
ATV630U15N4	144 x 350 x 203	5.67 x 13.78 x 7.99
ATV630U22N4	144 x 350 x 203	5.67 x 13.78 x 7.99
ATV630U30N4	144 x 350 x 203	5.67 x 13.78 x 7.99
ATV630U40N4	144 x 350 x 203	5.67 x 13.78 x 7.99
ATV630U55N4	144 x 350 x 203	5.67 x 13.78 x 7.99
ATV630U75N4	171 x 409 x 233	6.73 x 16.10 x 9.17
ATV630D11N4	171 x 409 x 233	6.73 x 16.10 x 9.17
ATV630D15N4	211 x 546 x 232	8.31 x 21.50 x 9.13
ATV630D18N4	211 x 546 x 232	8.31 x 21.50 x 9.13
ATV630D22N4	211 x 546 x 232	8.31 x 21.50 x 9.13
ATV630D30N4	226 x 673 x 271	8.90 x 26.50 x 10.67
ATV630D37N4	226 x 673 x 271	8.90 x 26.50 x 10.67
ATV630D45N4	226 x 673 x 271	8.90 x 26.50 x 10.67
ATV630D55N4	290 x 922 x 323	11.42 x 36.30 x 12.72
ATV630D75N4	290 x 922 x 323	11.42 x 36.30 x 12.72
ATV630D90N4	290 x 922 x 323	11.42 x 36.30 x 12.72
ATV630C11N4	320 x 852 x 390	12.60 x 33.54 x 15.35
With IP 21/UL Type 1 conformity kit	(1)	
ATV630C13N4	320 x 852 x 390	12.60 x 33.54 x 15.35
With IP 21/UL Type 1 conformity kit	(1)	
ATV630C16N4	320 x 852 x 390	12.60 x 33.54 x 15.35
With IP 21/UL Type 1 conformity kit	(1)	
ATV630C22N4	440 x 1195 x 380	17.32 x 47.06 x 14.96
With IP 21/UL Type 1 conformity kit	(1)	
ATV630C25N4	598 x 1195 x 380	23.54 x 47.06 x 14.96
With IP 21/UL Type 1 conformity kit	(1)	
ATV630C31N4	598 x 1195 x 380	23.54 x 47.06 x 14.96
With IP 21/UL Type 1 conformity kit	(1)	

(1) For further information, please contact our Customer Care Center.



380...480 V IP 55 drives

Overall dimensions

Drives	W x H x D	
	mm	in.
ATV650U07N4	264 x 678 x 272	10.39 x 26.69 x 10.71
ATV650U15N4	264 x 678 x 272	10.39 x 26.69 x 10.71
ATV650U22N4	264 x 678 x 272	10.39 x 26.69 x 10.71
ATV650U30N4	264 x 678 x 272	10.39 x 26.69 x 10.71
ATV650U40N4	264 x 678 x 272	10.39 x 26.69 x 10.71
ATV650U55N4	264 x 678 x 272	10.39 x 26.69 x 10.71
ATV650U75N4	264 x 678 x 299	10.39 x 26.69 x 11.77
ATV650D11N4	264 x 678 x 299	10.39 x 26.69 x 11.77
ATV650D15N4	264 x 678 x 299	10.39 x 26.69 x 11.77
ATV650D18N4	264 x 678 x 299	10.39 x 26.69 x 11.77
ATV650D22N4	264 x 678 x 299	10.39 x 26.69 x 11.77
ATV650D30N4	290 x 910 x 340	11.42 x 35.83 x 13.39
ATV650D37N4	290 x 910 x 340	11.42 x 35.83 x 13.39
ATV650D45N4	290 x 910 x 340	11.42 x 35.83 x 13.39
ATV650D55N4	345 x 1250 x 375	13.58 x 49.21 x 14.76
ATV650D75N4	345 x 1250 x 375	13.58 x 49.21 x 14.76
ATV650D90N4	345 x 1250 x 375	13.58 x 49.21 x 14.76

380...480 V IP 55 drives with Vario disconnect switch

Overall dimensions

Drives	W x H x D (1)	
	mm	in.
ATV650U07N4E	264 x 678 x 300	10.39 x 26.69 x 11.81
ATV650U15N4E	264 x 678 x 300	10.39 x 26.69 x 11.81
ATV650U22N4E	264 x 678 x 300	10.39 x 26.69 x 11.81
ATV650U30N4E	264 x 678 x 300	10.39 x 26.69 x 11.81
ATV650U40N4E	264 x 678 x 300	10.39 x 26.69 x 11.81
ATV650U55N4E	264 x 678 x 300	10.39 x 26.69 x 11.81
ATV650U75N4E	264 x 678 x 330	10.39 x 26.69 x 12.99
ATV650D11N4E	264 x 678 x 330	10.39 x 26.69 x 12.99
ATV650D15N4E	264 x 678 x 330	10.39 x 26.69 x 12.99
ATV650D18N4E	264 x 678 x 330	10.39 x 26.69 x 12.99
ATV650D22N4E	264 x 678 x 330	10.39 x 26.69 x 12.99
ATV650D30N4E	290 x 910 x 401	11.42 x 35.83 x 15.79
ATV650D37N4E	290 x 910 x 401	11.42 x 35.83 x 15.79
ATV650D45N4E	290 x 910 x 401	11.42 x 35.83 x 15.79
ATV650D55N4E	345 x 1250 x 436	13.58 x 49.21 x 17.17
ATV650D75N4E	345 x 1250 x 436	13.58 x 49.21 x 17.17
ATV650D90N4E	345 x 1250 x 436	13.58 x 49.21 x 17.17

(1) Add 60 mm/2.36 in. to the total depth to include the door handle.

Variable speed drives

Altivar Process

IP 21 and IP 54 drives: 380...440 V



Floor-standing 380...440 V IP 21 drives

Overall dimensions

Drives	W x H x D (1)	
	mm	in.
ATV630C11N4F	400 x 2150 x 605	15.75 x 84.65 x 23.82
ATV630C13N4F	400 x 2150 x 605	15.75 x 84.65 x 23.82
ATV630C16N4F	400 x 2150 x 605	15.75 x 84.65 x 23.82
ATV630C20N4F	600 x 2150 x 605	23.62 x 84.65 x 23.82
ATV630C25N4F	600 x 2150 x 605	23.62 x 84.65 x 23.82
ATV630C31N4F	600 x 2150 x 605	23.62 x 84.65 x 23.82

Floor-standing 380...440 V IP 54 drives

Overall dimensions

Drives	W x H x D (2)	
	mm	in.
ATV650C11N4F	400 x 2350 x 605	15.75 x 92.52 x 23.82
ATV650C13N4F	400 x 2350 x 605	15.75 x 92.52 x 23.82
ATV650C16N4F	400 x 2350 x 605	15.75 x 92.52 x 23.82
ATV650C20N4F	600 x 2350 x 605	23.62 x 92.52 x 23.82
ATV650C25N4F	600 x 2350 x 605	23.62 x 92.52 x 23.82
ATV650C31N4F	600 x 2350 x 605	23.62 x 92.52 x 23.82

(1) Add 42 mm/1.65 in. to the total depth in order to include the door handle.

(2) Add 60 mm/2.36 in. to the total depth in order to include the door handle. The total height includes a plinth of 200 mm/7.87 in.

Passive filters: 400 V 50 Hz three-phase supply		
Overall dimensions		
Passive filters	W x H x D	
	mm	in.
VW3A46101	190 x 332.11 x 205.5	7.48 x 13.08 x 8.09
VW3A46102	190 x 332.11 x 205.5	7.48 x 13.08 x 8.09
VW3A46103	190 x 332.11 x 205.5	7.48 x 13.08 x 8.09
VW3A46104	232 x 436.11 x 247.5	9.13 x 17.17 x 9.74
VW3A46105	232 x 436.11 x 247.5	9.13 x 17.17 x 9.74
VW3A46106	378 x 594.08 x 242	14.88 x 23.39 x 9.53
VW3A46107	378 x 594.08 x 242	14.88 x 23.39 x 9.53
VW3A46108	378 x 623.6 x 333	14.88 x 24.55 x 13.11
VW3A46109	378 x 623.6 x 333	14.88 x 24.55 x 13.11
VW3A46110	418 x 736.8 x 333	16.46 x 29.01 x 13.11
VW3A46111	418 x 736.8 x 333	16.46 x 29.01 x 13.11
VW3A46112	418 x 767.6 x 400	16.46 x 30.22 x 15.75
VW3A46113	418 x 767.6 x 400	16.46 x 30.22 x 15.75
VW3A46114	468 x 900.06 x 448.5	18.42 x 35.43 x 17.66
VW3A46115	468 x 900.06 x 448.5	18.42 x 35.43 x 17.66
VW3A46116	468 x 900.06 x 448.5	18.42 x 35.43 x 17.66
VW3A46118	420 x 800 x 448.5	16.54 x 31.50 x 17.66
VW3A46119	420 x 800 x 510	16.54 x 31.50 x 20.00
VW3A46120	190 x 332.11 x 205.5	7.48 x 13.08 x 8.09
VW3A46121	190 x 332.11 x 205.5	7.48 x 13.08 x 8.09
VW3A46122	190 x 332.11 x 205.5	7.48 x 13.08 x 8.09
VW3A46123	232 x 436.11 x 247.5	9.13 x 17.17 x 9.74
VW3A46124	232 x 436.11 x 247.5	9.13 x 17.17 x 9.74
VW3A46125	378 x 594.08 x 242	14.88 x 23.39 x 9.53
VW3A46126	378 x 594.08 x 242	14.88 x 23.39 x 9.53
VW3A46127	378 x 623.6 x 333	14.88 x 24.55 x 13.11
VW3A46128	378 x 623.6 x 333	14.88 x 24.55 x 13.11
VW3A46129	418 x 736.8 x 333	16.46 x 29.01 x 13.11
VW3A46130	418 x 736.8 x 333	16.46 x 29.01 x 13.11
VW3A46131	418 x 767.6 x 400	16.46 x 30.22 x 15.75
VW3A46132	418 x 767.6 x 400	16.46 x 30.22 x 15.75
VW3A46133	468 x 900.06 x 448.5	18.42 x 35.43 x 17.66
VW3A46134	468 x 900.06 x 448.5	18.42 x 35.43 x 17.66
VW3A46135	468 x 900.06 x 510	18.42 x 35.43 x 20.00
VW3A46137	420 x 800 x 510	16.54 x 31.50 x 20.00
VW3A46138	420 x 800 x 510	16.54 x 31.50 x 20.00

Passive filters: 460 V 60 Hz three-phase supply		
Overall dimensions		
Passive filters	W x H x D	
	mm	in.
VW3A46139	190 x 332.11 x 205.5	7.48 x 13.08 x 8.09
VW3A46140	190 x 332.11 x 205.5	7.48 x 13.08 x 8.09
VW3A46141	190 x 332.11 x 205.5	7.48 x 13.08 x 8.09
VW3A46142	232 x 436.11 x 247.5	9.13 x 17.17 x 9.74
VW3A46143	232 x 436.11 x 247.5	9.13 x 17.17 x 9.74
VW3A46144	378 x 594.08 x 242	14.88 x 23.39 x 9.53
VW3A46145	378 x 594.08 x 242	14.88 x 23.39 x 9.53
VW3A46146	378 x 594.08 x 242	14.88 x 23.39 x 9.53
VW3A46147	378 x 623.6 x 333	14.88 x 24.55 x 13.11
VW3A46148	378 x 623.6 x 333	14.88 x 24.55 x 13.11
VW3A46149	418 x 736.8 x 333	16.46 x 29.01 x 13.11
VW3A46150	418 x 736.8 x 333	16.46 x 29.01 x 13.11
VW3A46151	418 x 767.6 x 400	16.46 x 30.22 x 15.75
VW3A46152	418 x 767.6 x 400	16.46 x 30.22 x 15.75
VW3A46153	468 x 900.06 x 448.5	18.42 x 35.43 x 17.66
VW3A46154	468 x 900.06 x 448.5	18.42 x 35.43 x 17.66
VW3A46155	420 x 800 x 448.5	16.54 x 31.50 x 17.66
VW3A46157	420 x 800 x 510	16.54 x 31.50 x 20.00
VW3A46158	190 x 332.11 x 205.5	7.48 x 13.08 x 8.09
VW3A46159	190 x 332.11 x 205.5	7.48 x 13.08 x 8.09
VW3A46160	190 x 332.11 x 205.5	7.48 x 13.08 x 8.09
VW3A46161	232 x 436.11 x 247.5	9.13 x 17.17 x 9.74
VW3A46162	232 x 436.11 x 247.5	9.13 x 17.17 x 9.74
VW3A46163	378 x 594.08 x 242	14.88 x 23.39 x 9.53
VW3A46164	378 x 594.08 x 242	14.88 x 23.39 x 9.53
VW3A46165	378 x 594.08 x 242	14.88 x 23.39 x 9.53
VW3A46166	378 x 623.6 x 333	14.88 x 24.55 x 13.11
VW3A46167	378 x 623.6 x 333	14.88 x 24.55 x 13.11
VW3A46168	418 x 736.8 x 333	16.46 x 29.01 x 13.11
VW3A46169	418 x 736.8 x 333	16.46 x 29.01 x 13.11
VW3A46170	418 x 767.6 x 400	16.46 x 30.22 x 15.75
VW3A46171	418 x 767.6 x 400	16.46 x 30.22 x 17.75
VW3A46172	468 x 900.06 x 448.5	18.42 x 35.43 x 17.66
VW3A46173	468 x 900.06 x 510	18.42 x 35.43 x 20
VW3A46174	420 x 800 x 510	16.54 x 31.50 x 20.00
VW3A46176	420 x 800 x 510	16.54 x 31.50 x 20.00

Additional EMC input filters		
Overall dimensions		
EMC filters	W x H x D	
	mm	in.
VW3A4701	75 x 220 x 130	2.95 x 8.66 x 5.12
With IP 21/UL Type 1 conformity kit	77 x 220 x 130	3.03 x 8.66 x 5.12
VW3A4702	75 x 240 x 140	2.95 x 9.45 x 5.51
With IP 21/UL Type 1 conformity kit	77 x 240 x 140	3.03 x 9.45 x 5.12
VW3A4703	80 x 302 x 155	3.15 x 11.89 x 6.10
With IP 21/UL Type 1 conformity kit	83 x 302 x 155	3.27 x 11.89 x 6.10
VW3A4704	90 x 283 x 165	3.54 x 11.14 x 6.50
With IP 21/UL Type 1 conformity kit	93 x 283 x 165	3.66 x 11.14 x 6.50
VW3A4705	100 x 328 x 175	3.94 x 12.91 x 6.89
With IP 21/UL Type 1 conformity kit	103 x 328 x 175	4.05 x 12.91 x 6.89
VW3A4706	120 x 340 x 180	4.72 x 13.39 x 7.09
With IP 21/UL Type 1 conformity kit	123 x 340 x 180	4.84 x 13.39 x 7.09
VW3A4707	130 x 395 x 240	5.12 x 15.55 x 9.45
With IP 21/UL Type 1 conformity kit	134 x 395 x 240	5.28 x 15.55 x 9.45
VW3A4708	200 x 445 x 320	7.87 x 17.52 x 12.60
With IP 21/UL Type 1 conformity kit	204 x 445 x 320	8.03 x 17.52 x 12.60
VW3A4709	260 x 520 x 117	10.24 x 20.47 x 4.61
VW3A4710	260 x 520 x 117	10.24 x 20.47 x 4.61
VW3A4411	800 x 261 x 139	31.49 x 10.27 x 5.47

Variable speed drives

Altivar Process

dv/dt filters

dv/dt filters		
Overall dimensions		
dv/dt filters	W x H x D	
	mm	in.
VW3A5301	285 x 520 x 215	11.22 x 20.47 x 8.46
With IP 21/UL Type 1 conformity kit	285 x 530 x 215	11.22 x 20.87 x 8.46
VW3A5302	285 x 520 x 215	11.22 x 20.47 x 8.46
With IP 21/UL Type 1 conformity kit	285 x 530 x 215	11.22 x 20.87 x 8.46
VW3A5303	285 x 520 x 215	11.22 x 20.47 x 8.46
With IP 21/UL Type 1 conformity kit	285 x 530 x 215	11.22 x 20.87 x 8.46
VW3A5304	300 x 545 x 245	11.81 x 21.46 x 9.65
With IP 21/UL Type 1 conformity kit	300 x 560 x 245	11.81 x 22.05 x 9.65
VW3A5305	300 x 590 x 245	11.81 x 23.23 x 9.65
With IP 21/UL Type 1 conformity kit	300 x 610 x 245	11.81 x 24.02 x 9.65
VW3A5306	380 x 235 x 325	14.96 x 9.25 x 12.80
VW3A5307	420 x 270 x 350	16.54 x 10.63 x 13.78
VW3A5106	245 x 250 x 200	9.65 x 9.84 x 7.87
VW3A5107	320 x 250 x 220	12.60 x 9.84 x 8.66

Sinus filters		
Overall dimensions		
Sinus filters	W x H x D	
	mm	in.
VW3A5401	210 x 455 x 210	8.27 x 17.91 x 8.27
VW3A5402	210 x 455 x 210	8.27 x 17.91 x 8.27
VW3A5403	280 x 520 x 215	11.02 x 20.47 x 8.46
VW3A5404	300 x 545 x 245	11.81 x 21.46 x 9.64
VW3A5405	375 x 740 x 280	14.76 x 29.13 x 11.02
VW3A5406	430 x 350 x 495	16.93 x 13.78 x 19.49
VW3A5407	460 x 370 x 565	18.11 x 14.57 x 22.24
VW3A5209	480 x 340 x 600	18.90 x 13.38 x 23.62
VW3A5210	480 x 370 x 710	18.90 x 14.57 x 27.95

Common mode filter		
Overall dimensions		
Common mode filter	W x H x D	
	mm	in.
VW3A5501	66 x 119.2 x 66	2.60 x 4.69 x 2.60
VW3A5502	66 x 163.8 x 66	2.60 x 4.69 x 2.60
VW3A5503	127.5 x 161 x 127.5	5.02 x 6.34 x 5.02
VW3A5504	127.5 x 210 x 127.5	5.02 x 8.27 x 5.02
VW3A5505	191 x 197 x 196	7.52 x 7.76 x 7.72
VW3A5506	191 x 256 x 196	7.52 x 10.08 x 7.72

Variable speed drives

Altivar Process

A whole world of services for your drives by Schneider Electric



Presentation

Schneider Electric offers an extensive range of support services to help ensure the reliability of your installation in the long term, control your maintenance costs, and keep your process running at peak performance for maximum efficiency. Altivar Process has been designed in harmony with a whole range of services offered by Schneider Electric.

A worldwide network, 24/7: <ul style="list-style-type: none"> 400 highly qualified and certified experts Field service engineers, online experts 		A digital world of services: <ul style="list-style-type: none"> Schneider Electric Customer Care app Remote technical support 	
People			Digitized support material
Spare parts			Service provisions
A dedicated supply chain: <ul style="list-style-type: none"> All the spare parts you need Designed and manufactured by Schneider Electric 		An optimal life cycle model: <ul style="list-style-type: none"> Spare parts management, exchange and repairs Extended warranties, maintenance plans 	

Schneider Electric drive maintenance expert certification

- A worldwide network, 24/7:
- 400 highly qualified and certified experts
 - Our field service engineers follow a proven drives certification program designed to support you with maximum expertise and efficiency.
 - They use a range of professional tools and software to provide fast, in-depth diagnostics and repairs.

	Repair centers	Low voltage (LV) drives field service engineers	Medium voltage (MV) drives field service engineers
Module A	LV drive safety training		MV drive safety training
Module B	Technical training for LV drives		Technical training for MV drives
Module C	Repair center audit	Skills assessment	On-site start-up
Module D	Certification procedure		
Module E	Registration in Schneider Electric's international directory of Drives skills		
Module F	Re-certification every 2 years		

Variable speed drives

Altivar Process

A whole world of services for your drives by Schneider Electric

Drives support and services offer by Schneider Electric

Schneider Electric has developed a generic services offer to assist you throughout the life cycle of your product. From the planning stage right through to renewal, whether for standard or critical operations, you will find the solution you need in our set of standardized offers.

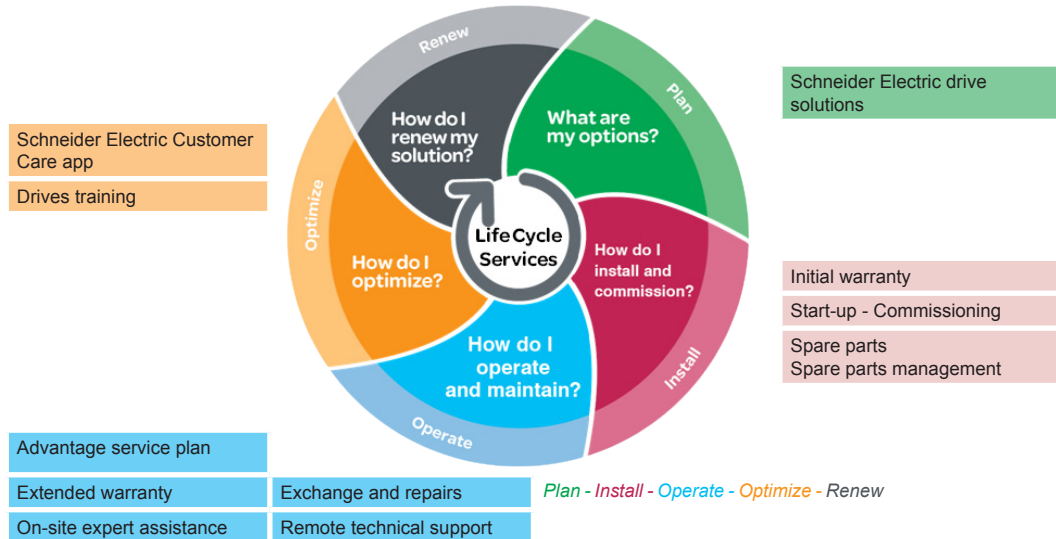

The offer	Contact, How to order	Description
Schneider Electric drive solutions	Contact your local Customer Care Center	Our Schneider Electric experts can help you design your installation, offering whatever type of assistance you need from technical support to turnkey solutions.
Start-up - Commissioning	Contact your local Customer Care Center	Our team of experts are specialists in installation commissioning and start-up whatever the conditions and for any application. This will extend your warranty period by an extra 6 months.
Spare parts - Spare parts management	Contact your local Customer Care Center	Our spare parts are available for the lifetime of your equipment. They are designed and manufactured to the same high quality standards as our products. They are available via a dedicated supply chain for emergency shipments. Our team can help you identify critical parts and define the right level of stock required. Whether stored in your premises (on-site) or in a central store (off-site), it is reassuring to know that critical spare parts are available 24/7.
Exchange and repairs	Contact your local Customer Care Center	Schneider Electric offers high-quality repair services via a global network of certified repair centers and certified field service engineers to cover any need: repairs in Schneider Electric repair centers, exchanges with refurbished products, or on-site repairs (Schneider Electric intervention on your premises).
Remote technical support	Contact your local Customer Care Center	Direct priority access to our experts to help you solve any technical difficulties. Our experts have extensive field experience and have fully mastered the technologies implemented. A simple phone conversation or on-line chat is usually sufficient to help you find the optimal solution and can help keep your costs down by avoiding on-site intervention.
On-site technical support	Contact your local Customer Care Center	Our field service engineers can support your maintenance staff in their everyday operations, or engage when requested in the event of an emergency.
Extended warranty	Contact your local Customer Care Center	Spare parts and repairs performed by Schneider Electric experts on duty.
Advantage service plan	Contact your local Customer Care Center	The Advantage Service plan combines the Preventive Maintenance program (annual visit for inspection, checks, and replacement of worn parts) with the extended warranty (covering spare parts and repairs), plus remote technical support.
Drives training	Contact your local Customer Care Center	A comprehensive suite of training courses to master your Altivar Process drive at any stage in the life cycle of your installation.
mySchneider Customer Care app	Download from the Apple Store® or Google Play Store™	Free download from the Apple Store® or Google Play Store™. Immediate access to Schneider Electric Customer Care Centers, product documentation, FAQs, Cloud services, etc. and plenty of other services yet to come.

4							
490NTC00005	36	ATV630U30M3	16	NSYCAF223	23	VW3A4708	48
	37	ATV630U30N4	17	NSYCAF291	23	VW3A4709	48
490NTC00005U	36	ATV630U40M3	16	NSYPTDS1	23	VW3A4710	48
	37	ATV630U40N4	17	NSYPTDS2	23	VW3A5106	51
490NTC00015	36	ATV630U55M3	16	NSYPTDS3	23	VW3A5107	51
	37	ATV630U55N4	17	NSYPTDS4	23	VW3A5209	53
490NTC00015U	36	ATV630U75M3	16	NSYPTDS5	23	VW3A5210	53
	37	ATV630U75N4	17			VW3A5301	50
490NTW00002	36	ATV650C11N4F	12	T			51
	37		22	TCSCAR01NM120	39	VW3A5302	50
490NTW00002U	36	ATV650C13N4F	22	TCSCAR013M120	38		51
	37	ATV650C16N4F	22	TCSEGB13FA0	24	VW3A5303	50
490NTW00005	36	ATV650C20N4F	22	TCSCXNAMUM3P	25		51
	37	ATV650C25N4F	22	TSXCANCA50	38	VW3A5304	50
490NTW00005U	36	ATV650C31N4F	22	TSXCANCA100	38		51
	37	ATV650D11N4	19	TSXCANCA300	38	VW3A5305	50
490NTW00012	36	ATV650D11N4E	20	TSXCANCADD1	39		51
	37	ATV650D15N4	19	TSXCANCADD03	39	VW3A5306	50
490NTW00012U	36	ATV650D15N4E	20	TSXCANCADD03	39		51
	37	ATV650D18N4	19	TSXCANCB50	38	VW3A5307	50
A		ATV650D18N4E	20	TSXCANCB100	38		51
ATV630C11N4	18	ATV650D22N4	19	TSXCANCB300	38	VW3A5401	52
ATV630C11N4F	12	ATV650D22N4E	20	TSXCANCBDD3	39		53
	21	ATV650D30N4	19	TSXCANCBDD5	39	VW3A5402	52
ATV630C13N4	18	ATV650D30N4E	20	TSXCANCD50	38		53
ATV630C13N4F	21	ATV650D37N4	19	TSXCANCD100	38	VW3A5403	52
ATV630C16N4	18	ATV650D37N4E	20	TSXCANCD300	38		53
ATV630C16N4F	21	ATV650D45N4	19	TSXCANKCDF180T	38	VW3A5404	52
ATV630C20N4F	21	ATV650D45N4E	20	TSXCANTDM4	39		53
ATV630C22N4	18	ATV650D55N4	19			VW3A5405	52
ATV630C25N4	18	ATV650D55N4E	20	V			53
ATV630C25N4F	21	ATV650D75N4	19	VW3A1104R10	25	VW3A5406	52
ATV630C31N4	18	ATV650D75N4E	20	VW3A1104R30	25		53
ATV630C31N4F	21	ATV650D90N4	19	VW3A1104R50	25	VW3A5407	52
ATV630D11M3	16	ATV650D90N4E	20	VW3A1104R100	25		53
ATV630D11N4	17	ATV650U07N4	12	VW3A1111	24	VW3A5408	52
ATV630D15M3	16		19	VW3A1112	25		53
ATV630D15N4	17	ATV650U07N4E	12	VW3A1115	25	VW3A8306R03	25
ATV630D18M3	16		20	VW3A1116	25		36
ATV630D18N4	17	ATV650U15N4	19	VW3A3203	33	VW3A8306R10	25
ATV630D22M3	16	ATV650U15N4E	20	VW3A3204	33		36
	17	ATV650U22N4	19	VW3A3607	40	VW3A8306R30	25
ATV630D22N4	17	ATV650U22N4E	20	VW3A3608	38		36
ATV630D30M3	16	ATV650U30N4	19	VW3A3609	41	VW3A8306RC	25
ATV630D30N4	17	ATV650U30N4E	20	VW3A3618	38		36
ATV630D37M3	16	ATV650U40N4	19	VW3A3627	40	VW3A8306TF03	25
ATV630D37N4	17	ATV650U40N4E	20	VW3A3628	39		36
ATV630D45M3	16	ATV650U55N4	19	VW3A3720	37	VW3A9112	23
ATV630D45N4	17	ATV650U55N4E	20	VW3A3721	37		23
ATV630D55M3	16	ATV650U75N4	19	VW3A4411	48	VW3A9212	23
ATV630D55N4	18	ATV650U75N4E	20	VW3A4701	48		23
ATV630D75M3	16			VW3A4702	48	VW3A9613	51
ATV630D75N4	18	L		VW3A4703	48		51
ATV630D90N4	18	LU9AD7	40	VW3A4704	48	VW3A9704	23
ATV630U07M3	12	LU9GC3	25	VW3A4705	48	VW3A46101	43
	16		36	VW3A4706	48	VW3A46102	43
ATV630U07N4	12	N		VW3A4707	48	VW3A46103	43
	17	NSYAEFPFPTD	23			VW3A46104	43
ATV630U15M3	16			VW3A4708	48	VW3A46105	43
ATV630U15N4	17			VW3A4709	48	VW3A46106	43
ATV630U22M3	16			VW3A4710	48	VW3A46107	43
ATV630U22N4	17			VW3A5106	51	VW3A46108	43
				VW3A5107	51	VW3A46109	43
				VW3A5209	53	VW3A46110	43
				VW3A5210	53	VW3A46111	43
				VW3A5301	50	VW3A46112	43
				VW3A5302	50	VW3A46113	43
				VW3A5303	50	VW3A46114	43
				VW3A5304	50	VW3A46115	43
				VW3A5305	50	VW3A46116	43
				VW3A5306	50	VW3A46118	43
				VW3A5307	50	VW3A46119	43
				VW3A5401	52	VW3A46120	44
				VW3A5402	52	VW3A46121	44
				VW3A5403	52	VW3A46122	44
				VW3A5404	52	VW3A46123	44
				VW3A5405	52	VW3A46124	44
				VW3A5406	52	VW3A46125	44
				VW3A5407	52	VW3A46126	44
				VW3A8306R03	25	VW3A46127	44
					36	VW3A46128	44
				VW3A8306R10	25	VW3A46129	44
					36	VW3A46130	44
				VW3A8306R30	25	VW3A46131	44
					36	VW3A46132	44
				VW3A8306RC	25	VW3A46133	44
					36	VW3A46134	44
				VW3A8306TF03	25	VW3A46135	44
					36	VW3A46137	44
				VW3A8306TF10	25	VW3A46138	44
					36	VW3A46139	45
				VW3A9112	23	VW3A46140	45
				VW3A9113	23	VW3A46141	45
				VW3A9212	23	VW3A46142	45
				VW3A9213	23	VW3A46143	45
				VW3A9613	51	VW3A46144	45
				VW3A9704	23	VW3A46145	45
				VW3A46101	43	VW3A46146	45
				VW3A46102	43	VW3A46147	45
				VW3A46103	43	VW3A46148	45
				VW3A46104	43	VW3A46149	45
				VW3A46105	43	VW3A46150	45
				VW3A46106	43	VW3A46151	45
				VW3A46107	43	VW3A46152	45
				VW3A46108	43	VW3A46153	45
				VW3A46109	43	VW3A46154	45
				VW3A46110	43	VW3A46155	45
				VW3A46111	43	VW3A46157	45
				VW3A46112	43	VW3A46158	46
						VW3A46159	46
						VW3A46160	46
						VW3A46161	46
						VW3A46162	46
						VW3A46163	46
						VW3A46164	46
						VW3A46165	46
						VW3A46166	46
						VW3A46167	46
						VW3A46168	46
						VW3A46169	46
						VW3A46170	46
						VW3A46171	46

VW3A46172	46
VW3A46173	46
VW3A46174	46
VW3A46176	46
VW3A47901	49
VW3A47902	49
VW3A47903	49
VW3A47904	49
VW3A47905	49
VW3A47906	49
VW3A47907	49
VW3A47908	49
VW3A53901	53
VW3A53902	51 53
VW3A53903	51 53
VW3A53904	53
VW3A53905	51
VW3CANCARR1	38
VW3CANCARR03	38
VW3CANTAP2	39
VX5VP50A001	23
VX5VP50BC001	23
VX5VPM001	23
VX5VPM002	23
VX5VPS1001	23
VX5VPS2001	23
VX5VPS3001	23
VX5VPS4001	23
VX5VPS5001	23
VX5VPS6001	23
VZ3V1212	23
VZ3V1213	23
Z	
ZB5AZ905	25

Altivar drives



Schneider Electric Industries SAS

Head Office
35, rue Joseph Monier
F-92500 Rueil-Malmaison
France

www.schneider-electric.com/drives

The information provided in this documentation contains general descriptions and/or technical characteristics of the performance of the products contained herein. This documentation is not intended as a substitute for and is not to be used for determining suitability or reliability of these products for specific user applications. It is the duty of any such user or integrator to perform the appropriate and complete risk analysis, evaluation and testing of the products with respect to the relevant specific application or use thereof. Neither Schneider Electric nor any of its affiliates or subsidiaries shall be responsible or liable for misuse of the information contained herein.

Design: Schneider Electric
Photos: Schneider Electric