



# Owner's Manual

## TABLE OF CONTENTS

	PAGE
A NOTE ABOUT SAFETY .....	2
GENERAL .....	2
PART NAMES AND DISPLAY .....	3
WIRELESS REMOTE CONTROL .....	4
REMOTE CONTROL .....	6
FEATURES .....	9
CLEANING, MAINTENANCE AND TROUBLESHOOTING .....	11

### NOTE TO EQUIPMENT OWNER:

Please read this Owner's Information Manual carefully before installing and using this appliance and keep this manual for future reference.

For your convenience, please record the model and serial numbers of your new equipment in the spaces provided. This information, along with the installation data and dealer contact information, will be helpful should your system require maintenance or service.

#### UNIT INFORMATION

Model # \_\_\_\_\_

Serial # \_\_\_\_\_

#### INSTALLATION INFORMATION

Date Installed \_\_\_\_\_

#### DEALERSHIP CONTACT INFORMATION

Company Name: \_\_\_\_\_

Address: \_\_\_\_\_

Phone Number: \_\_\_\_\_

Technician Name: \_\_\_\_\_

## A NOTE ABOUT SAFETY

Any time you see this symbol  in manuals, instructions and on the unit, be aware of the potential for personal injury. **There are 3 levels of precaution:**

1. **DANGER** identifies the most serious hazards which will result in severe personal injury or death.
2. **WARNING** signifies hazards that could result in personal injury or death.
3. **CAUTION** is used to identify unsafe practices which could result in minor personal injury or product and property damage.

**NOTE** is used to highlight suggestions which will result in enhanced installation, reliability, or operation.

WARNING

**PERSONAL INJURY, DEATH AND / OR PROPERTY DAMAGE HAZARD**

Failure to follow this warning could result in personal injury, death or property damage.

Improper installation, adjustment, alteration, service, maintenance, or use can cause explosion, fire, electrical shock, or other conditions which may cause personal injury or property damage. Consult a qualified installer, service agency, or your distributor or branch for information or assistance. The qualified installer or service agency must use factory-authorized kits or accessories when modifying this product.

Read and follow all instructions and warnings, including labels shipped with or attached to unit before operating your new air conditioner.

## GENERAL

The high wall fan coil unit provides quiet, maximum comfort. In addition to cooling and/or heating, the high wall fan coil unit matched with an outdoor condensing unit filters and dehumidifies the air in the room to provide maximum comfort.

**IMPORTANT:** The high wall fan coil unit should be installed by authorized personnel only; using approved tubing and accessories. If technical assistance, service or repair is needed, contact the installer. The high wall fan coil unit can be set up and operated from the remote control (provided). **If the remote is misplaced, the system can be operated from the “Auto” setting on the unit.**

### Operating Modes

The high wall fan coil unit has five operating modes:

- **FAN Only**
- **AUTO**
- **HEATING (heat pumps only)**
- **COOLING**
- **DEHUMIDIFICATION**

#### FAN Only

In the **FAN Only** mode, the system filters and circulates the room air without changing room air temperature.

#### AUTO

In the **AUTO** mode, the system automatically cools or heats the room according to the user-selected set point.

**NOTE: AUTO mode is recommended for use on single zone applications ONLY. Using AUTO CHANGEOVER on multi-zone applications could set an indoor unit to STANDBY mode, indicated with two dashes (--) on the display, which will turn off the indoor unit until all the indoor units are in the same mode (COOLING or HEATING). HEATING is the system's priority mode. Simultaneous HEATING and COOLING is not allowed.**

#### HEATING

In the **HEATING** mode, the system heats and filters the room air.

#### COOLING

In the **COOLING** mode, the system cools, dries and filters the room air.

#### DEHUMIDIFICATION (DRY)

In the **DEHUMIDIFICATION** mode, the system dries, filters and slightly cools the room air temperature. This mode prioritizes air dehumidification but it does not take the place of a dehumidifier.

### Wireless Remote Control

The remote control transmits commands to set up and operate the system. The control has a window display panel that displays the current system status. The control can be secured to a surface when used with the mounting bracket provided.

### Wired Remote Control (Optional)

Refer to the Wired Controller manual.

### 24V Interface (Optional)

Allows the control of the Ductless System with a third party thermostat.

### Smartphone Control (Optional)

Capability to be controlled by a smartphone adding the Wi-Fi® Interface Kit KSAIF0301AAA (sold separately).

## PART NAMES AND DISPLAY

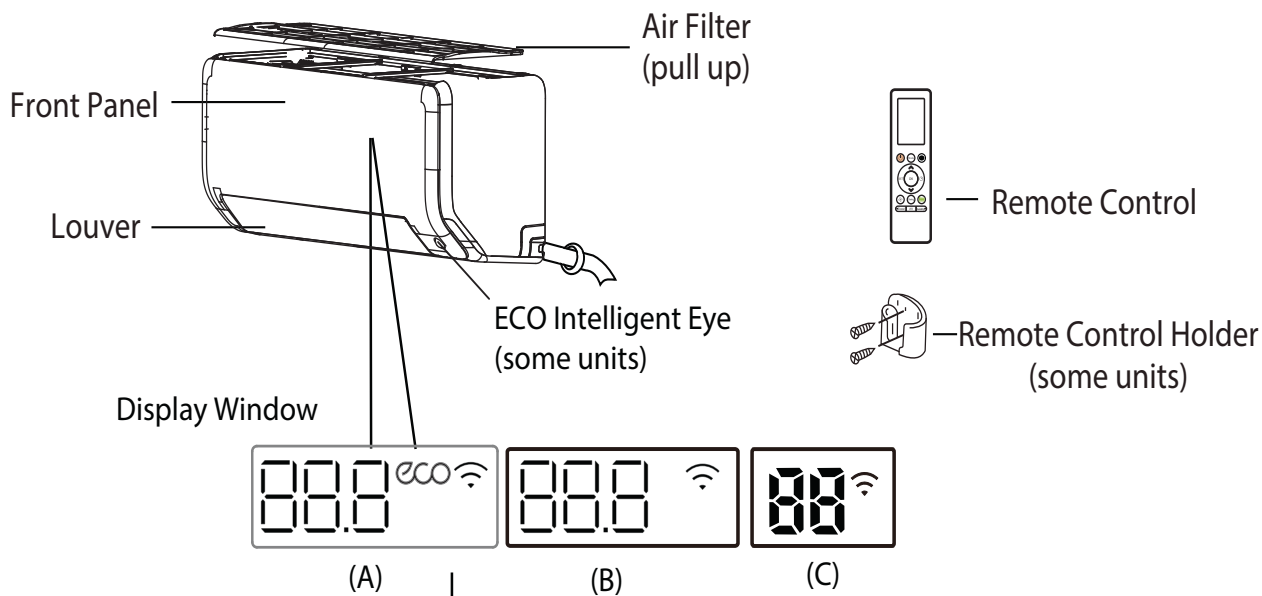

**88.8** Displays temperature, operation feature and Error Codes:

**00** for 3 seconds when:

- TIMER ON is set (if the unit is OFF, **00** remains on when TIMER ON is set )

- FRESH , SWING, TURBO , ECO, BREEZE AWAY, ECO INTELLIGENT EYE or SILENCE feature is turned on

**0F** for 3 seconds when:

- TIMER OFF is set
- FRESH, SWING, TURBO, ECO, BREEZE AWAY, ECO INTELLIGENT EYE or SILENCE feature is turned off

**df** when defrosting

**CL** when Active Clean feature is turned on(for Inverter split type )

**FP** when 46°F (8°C) heating mode is turned on (some units)

**ECO** when ECO feature is activated (some units)

**📶** when wireless control feature is activated (some units)

Display Code Meanings

NOTE: Different models have different front panels and display windows. Not all the indicators described above are available for the air conditioner you purchased. Please check the indoor display window of the unit you purchased.

Illustrations in this manual are for reference purposes. The actual shape of your indoor unit may differ slightly.

**Fig. 1 — Indoor Unit**

# WIRELESS REMOTE CONTROL

Before you begin using your new air conditioner, familiarize yourself with the remote control.

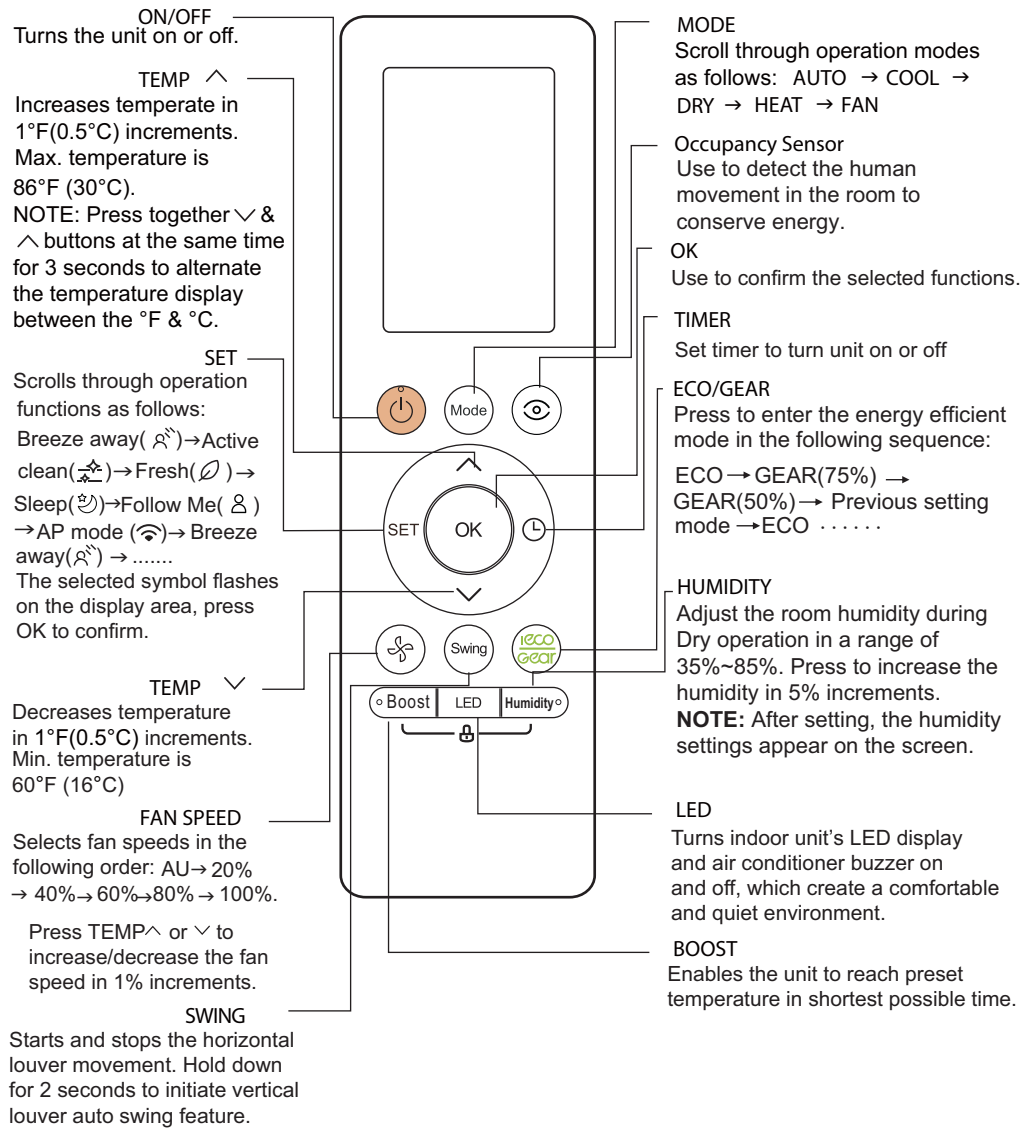

**Fig. 2 — Remote Control Functions**

# WIRELESS REMOTE CONTROL LCD SCREEN INDICATORS

Information appears when the remote controller is on.

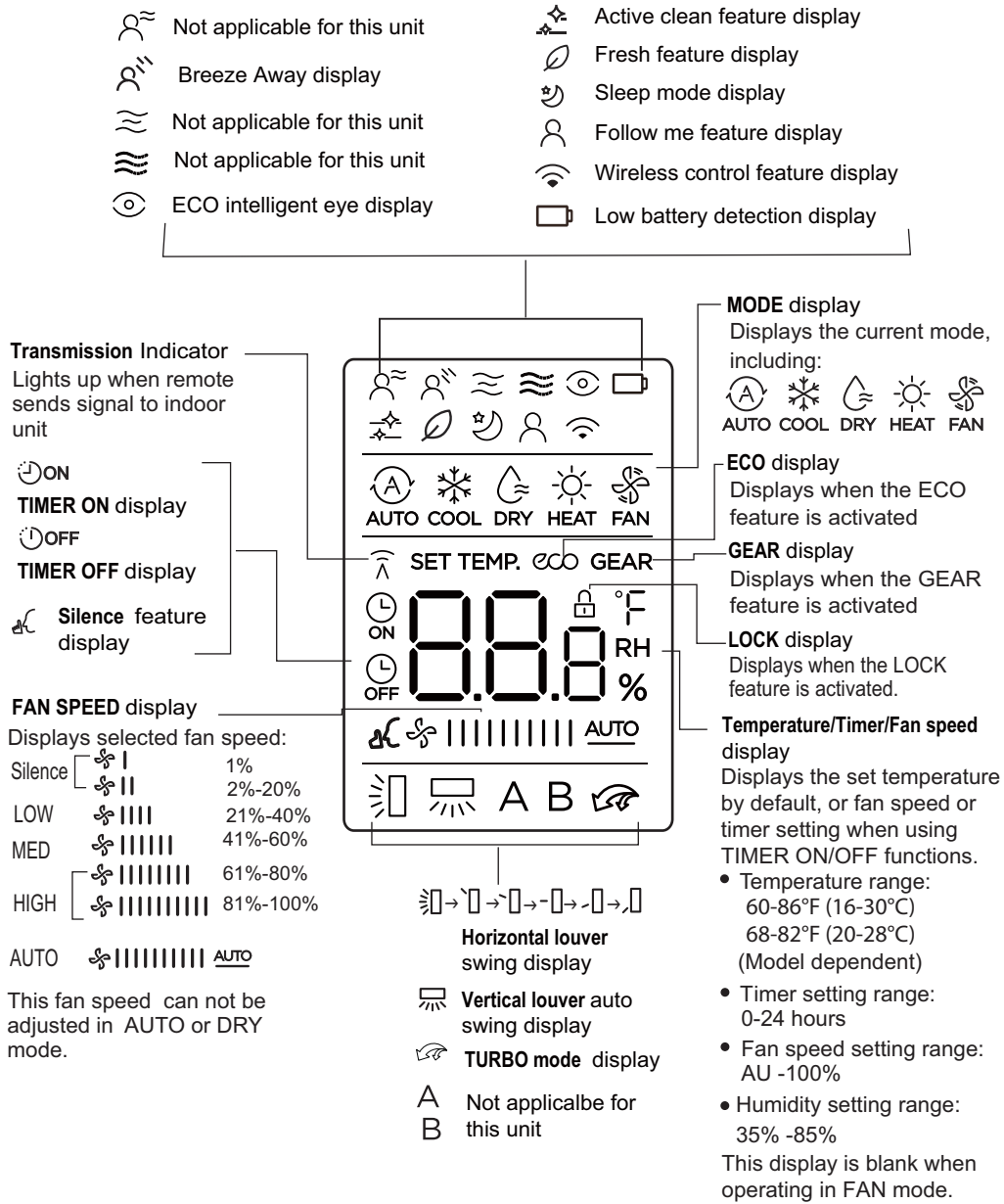

Fig. 3 — Wireless Remote Controller Indicators

## REMOTE CONTROL



### CAUTION

#### EQUIPMENT DAMAGE HAZARD

Failure to follow this caution may result in equipment damage. Handle the control with care and avoid getting the control wet.

**IMPORTANT:** The remote control can operate the unit from a distance of up to 26 ft. (8 m) as long as there are no obstructions. When the timer function is used, the remote control should be kept in the vicinity of the fan coil (within 26 ft. / 8 m).

The remote control can perform the following basic functions:

- **Turn the system ON and OFF**
- **Select the operating mode**
- **Adjust room air temperature set point and fan speed**
- **Adjust right-left airflow direction**

Refer to the “WIRELESS REMOTE CONTROL” on page 4 for a detailed description of all the capabilities of the remote control.

### Battery Installation

Two AAA 1.5v alkaline batteries (included) are required for remote control operation.

#### To install or replace batteries:

1. Slide the back cover off the control to open the battery compartment.
2. Insert the batteries. Follow the polarity markings inside the battery compartment.
3. Replace the battery compartment cover.

#### NOTES:

1. When replacing batteries, do not use old batteries or a different type battery. This may cause the remote control to malfunction.
2. If the remote is not going to be used for several weeks, remove the batteries. Otherwise, battery leakage may damage the remote control.
3. The average battery life under normal use is about 6 months.
4. Replace the batteries when there is no audible beep from the indoor unit or if the Transmission Indicator fails to light.

When batteries are removed, the remote control erases all presets (e.g., **Follow Me**). The presets must be restored after the insertion of new batteries.

## BASIC REMOTE CONTROL OPERATION

Before operation, ensure the unit is plugged in and power is available.

### COOL Mode

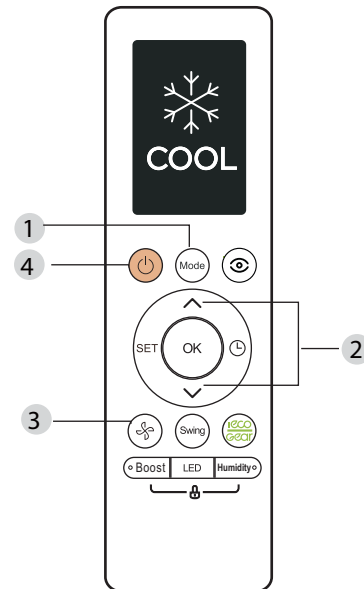

**Fig. 4 — COOL Mode**

1. Press **MODE** to select the **COOL** mode.
2. Set your desired temperature using **TEMP ▲** or **TEMP ▼**.
3. Press **FAN** to select the fan speed in a range of AU\*100%.
4. Press **ON/OFF** to start the unit.

### Setting Temperature

The operating temperature range for units is 60-86°F (16-30°C)/(68-82 °F (20-28°C) (depends on model). You can increase or decrease the set temperature in 1°F(0.5°C) increments.

### HEAT Mode

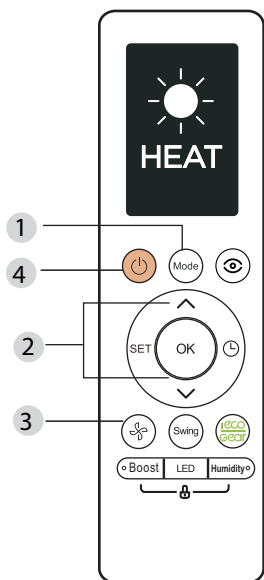

Fig. 5 — HEAT Mode

1. Press **MODE** to select the **HEAT** mode.
2. Set your desired temperature using **TEMP ▲** or **TEMP ▼**.
3. Press **FAN** to select the fan speed in the range of AU-100%.

**NOTE:** As the outdoor temperature drops, the performance of your unit's **HEAT** function may be affected. In such instances, we recommend using this air conditioner in conjunction with other heating appliances.

### AUTO Mode

In **AUTO** mode, the unit automatically selects the **COOL**, **FAN**, or **HEAT** operation based on the set temperature.

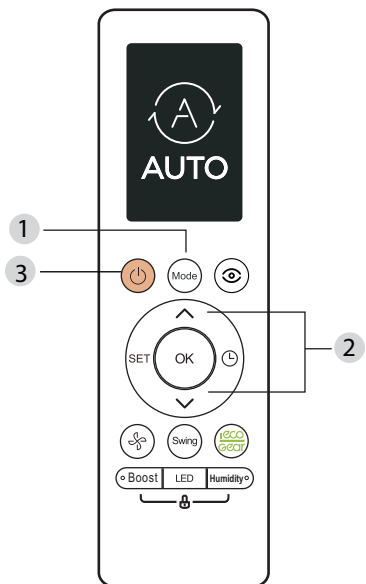

Fig. 6 — AUTO Mode

1. Press **MODE** to select **AUTO**.
2. Set your desired temperature using **TEMP ▲** or **TEMP ▼**.
3. Press **ON/OFF** to start the unit.

**NOTE:** **FAN** Speed can not be set in the **AUTO** mode.

### DRY Mode

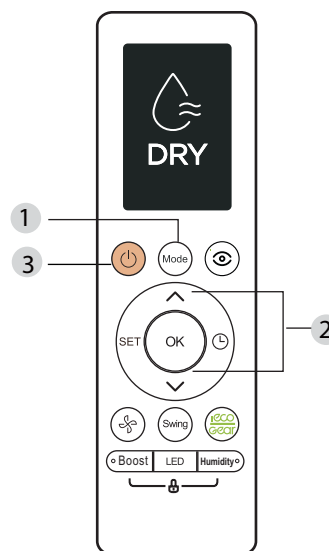

Fig. 7 — DRY Mode

1. Press **MODE** to select the **DRY** mode.
2. Set your desired temperature using **TEMP ▲** or **TEMP ▼**.
3. Press **ON/OFF** to start the unit.

### FAN Mode

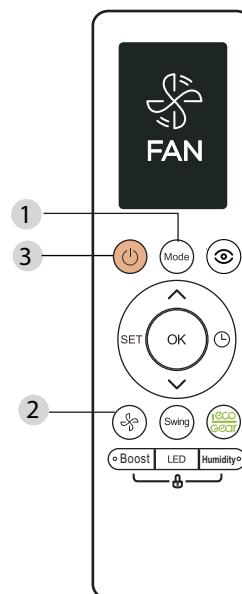

Fig. 8 — FAN Mode

1. Press **MODE** to select the **FAN** mode.
2. Press **FAN** to select the fan speed in the range of AU-100%.
3. Press **ON/OFF** to start the unit.

## Remote Control Operation - Quick Start

**NOTE:** When transmitting a command from the remote control to the unit, be sure to point the control toward the right side of the unit. The unit confirms receipt of a command by sounding an audible beep.

1. Turn the unit on by pushing **ON/OFF**.  
**NOTE:** If there is a preference for °C rather than °F (default), press and hold the + and - temperature set point buttons together for approximately 3 seconds.
2. Select the desired mode by pushing **MODE**.

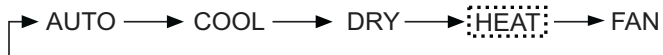

**Fig. 9 —Modes**

3. Select the temperature set point by pointing the control toward the unit and pressing the increase/decrease temperature set point buttons until the desired temperature appears on screen.
4. Press **FAN** to select the desired fan speed.

**NOTE:** If the unit is operating in **DRY** or **AUTO** mode, the fan speed will be automatically set and cannot be adjusted.

Set the airflow direction. When the unit is turned on, the **Up-Down** airflow louvers default to the cooling or heating position. The user can adjust the horizontal **Up-Down** airflow louver position by pushing **DIRECT** or have continuous louver movement by pressing **SWING**.

When the outside temperature is below 32°F (0°C), we strongly recommend maintaining power on the unit to ensure smooth ongoing performance.

To optimize unit performance, perform the following:

- Keep doors and windows closed
- Limit energy usage by using **TIMER ON** and **TIMER OFF** functions.
- Do not block air inlets or outlets.
- Regularly inspect and clean air filters.



## FEATURES

The unit provides the following features for added comfort and safety.

### Time Delay

If **ON/OFF** is pressed too soon after a stop, the compressor will not start for 3 to 4 minutes due to the inherent protection against frequent compressor cycling. The unit only emits an audible beep when the signals are received correctly.

### Heating

If the unit is in **HEATING** mode, there is a delay when the fan starts. The fan starts only after the coil is warmed up to prevent cold blow.

### Auto Defrost Operation

In the **HEATING** mode, if the outdoor coil is frosted, the indoor fan and outdoor fan turns off while the system removes the frost on the outdoor coil. The system automatically reverts to normal operation when frost is removed from the outdoor unit.

### Auto Start

If the power fails while the unit is operating, the unit stores the operating condition, and it will start operation automatically under those conditions when the power is restored.

### Auto-Restart (some units)

If the unit loses power, it automatically restarts with the prior settings once power has been restored.

### Anti-mildew (some units)

When turning off the unit from **COOL**, **AUTO (COOL)**, or **DRY** modes, the air conditioner continues to operate at very low power to dry up any condensed water and prevent mildew growth.

### Wireless Control (some units)

Wireless control allows users to control the air conditioner using a mobile phone and a wireless connection. For the USB device access, replacement, maintenance operations must be carried out by professional staff.

### Louver Angle Memory (some units)

When turning on the unit, the louver automatically resumes its former angle.

### Active Clean (some units)

The **Active Clean Technology** washes away dust, mold, and grease that may cause odors when it adheres to the heat exchanger by automatically freezing and then rapidly thawing the frost. The operation produces more condensed water to improve the cleaning effect.

After cleaning, the blower wheel keeps operating with hot air to blow-dry the evaporator, thus preventing the growth of mold and keeping the inside clean. When this function is turned on, the indoor unit window displays **CL**. After 20 to 45 minutes, the unit turns off automatically and cancels the function.

### Breeze Away (some units)

This feature avoids direct air flow from blowing on inhabitants.

### Refrigerant Leak Detection (some units)

The indoor unit automatically displays **EL0C** when it detects refrigerant leakage.

### Occupancy Sensor (some units)

The system is controlled intelligently under the **Occupancy Sensor** mode. The feature detects the movement in the room. In **COOLING** mode, when occupants are away for 30 minutes, the unit automatically lowers the frequency to save energy (for Inverter models only). And the unit automatically starts and resumes operation when movement is detected.

### Resetting the Remote Control

If the batteries in the remote control are removed, the current settings cancel and the control returns to the initial settings and enters the **STANDBY mode**. Push **ON/OFF** to activate.

**NOTE: For multi-zone air conditioners, the following functions are not available: ACTIVE CLEAN, SILENCE, BREEZE AWAY, REFRIGERANT LEAKAGE DETECTION and ECO.**

### Setting Vertical Angle of Air Flow

While the unit is on, press **SWING** on the remote control to initiate the horizontal louver **AUTO SWING** feature.

**NOTE: When using the COOL or DRY mode, do not set the louver at too high of an angle for long periods of time. Doing so can cause water to condense on the louver blade, which may drop on your floor or furnishings.**

**When using the COOL or HEAT mode, setting the louver at too high of an angle can reduce the performance of the unit due to restricted air flow.**

### Setting Horizontal Angle of Air Flow

When the unit is on, press and hold **SWING** for 2 seconds on the remote control to initiate the vertical louver auto swing feature to control the horizontal angle of the airflow.

### ECO/Gear Function

Used to enter the **ENERGY EFFICIENT** mode and is only available in the **COOLING** mode. When in **COOLING** mode, press **ECO/GEAR**, the remote controller will maintain the temperature automatically between 75°F and 86°F, and set the fan speed to Auto.

Operation time in the **ECO** mode is 8 hours. After 8 hours, or if a conflicting setting is engaged, the air conditioner exits this mode.

Gear operation is engaged by cycling through the **ECO/GEAR** operations. After **ECO**, there is a setting for up to 75% and 50% of the unit's electrical consumption. The last step in the cycle is the previous unit setting before **ECO** setting is engaged again and the cycle starts over.

### Manual Operation (without remote control)

The manual button is intended for testing purposes and emergency operation **only**. Please do not use this function unless the remote control is lost and it is absolutely necessary. To restore regular operation, use the remote control to activate the unit. The unit must be turned off before manual operation.

Use the following steps to operate the unit manually:

1. Locate the **MANUAL CONTROL** button on the right-hand side panel of the unit.
2. Press **MANUAL CONTROL** one time to activate **FORCED AUTO** mode.
3. Press **MANUAL CONTROL** again to activate the **FORCED COOLING** mode.
4. Press **MANUAL CONTROL** a third time to turn the unit off.

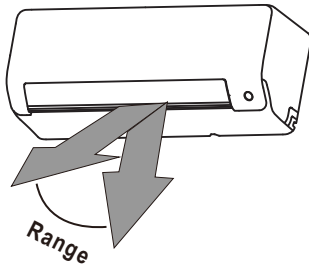
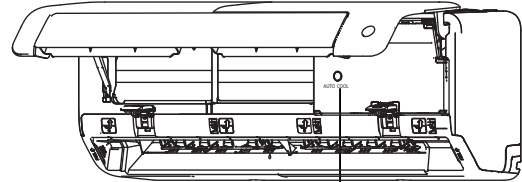

Fig. 10 — Range

**NOTE: DO NOT** move louver by hand. Doing so takes the louver out of sync. Should this occur, turn off the unit and unplug it for a few seconds, then restart the unit. Doing so resets the louver.

**⚠ CAUTION**

**DO NOT** put your fingers in or near the blower and suction unit side of the unit. The high-speed fan inside the unit may cause injury.



Manual Control Button

Fig. 11 — Manual Control Button

## CLEANING, MAINTENANCE AND TROUBLESHOOTING



### CAUTION

#### ELECTRICAL SHOCK HAZARD

Failure to follow this caution may result in personal injury or death. Always turn off power to the system before performing any cleaning or maintenance to the system. Turn off the outdoor disconnect switch located near outdoor unit.

Be sure to disconnect the indoor unit if on a separate switch.



### CAUTION

#### EQUIPMENT DAMAGE/OPERATION HAZARD

Failure to follow this caution may result in equipment damage or improper unit operation.

Operating the system with dirty air filters may damage the indoor unit and could cause reduced cooling performance, intermittent system operation, frost build-up on indoor coil or blown fuses.

### Periodic Maintenance

Periodic maintenance is recommended to ensure proper operation of the unit. Recommended maintenance intervals may vary depending on the installation environment, e.g., dusty zones, etc. Refer to Table 1 on page 13.



### CAUTION

#### CUT HAZARD

Failure to follow this caution may result in personal injury. The coil fins are very sharp. Use caution when cleaning.

Always wear safety protection.

### Cleaning the Coil

Clean the coil at the beginning of each cooling season, or when necessary. Use a vacuum cleaner or a long-bristle brush to avoid damage to the coil fins.

### Cleaning the Air Filters

Remove and clean the air filters once a month. A clogged air conditioner can reduce the cooling efficiency of your unit, and can also be bad for your health.

**NOTE: If air filters show signs of excessive wear or are torn, they must be replaced. Contact your local dealer for replacement filters.**

1. The air filter is on the top of the air conditioner.
2. Hold both side of the top filter in the place marked with **PULL**, then pull it upwards.
3. If the filter has small air freshening filters, unclip them from the larger filter. Clean these air freshening filters with a hand-held vacuum.
4. Clean the large air filter with warm, soapy water. Be sure to use a mild detergent.
5. Rinse the filter with fresh water, then shake off any excess water.
6. Dry the filter in a cool, dry place, and refrain from exposing it to direct sunlight.
7. When dry, re-clip the air freshening filter to the larger filter, then install it back on the indoor unit.

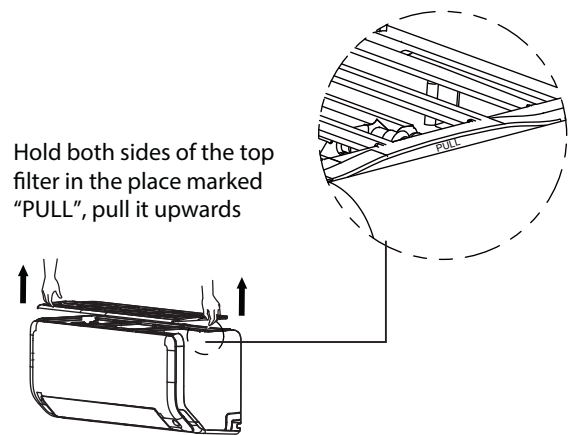

Fig. 12 — Hold and Pull the filter

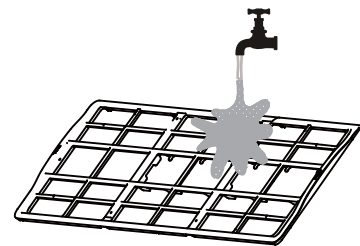
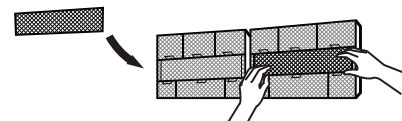

Fig. 13 — Rinse



Remove air freshening filter from back of larger filter (some units), clean with a hand-held vacuum.

Fig. 14 — Remove the air freshening filter



### CAUTION

Before changing the filter or cleaning, turn off the unit and disconnect its power supply.

When removing the filter, do not touch metal parts in the unit. The sharp metal edges can cut you.

Do not use water to clean the inside of the indoor unit. This can destroy insulation and cause an electrical shock.

Do not expose filter to direct sunlight when drying. This can shrink the filter.

### Cleaning the Indoor Unit Front Panel

To clean the front panel on the indoor unit, wipe the outside with a soft, dry cloth.

## Pre-Season Inspection

After long periods of non-use, or before periods of frequent use, perform the following steps:

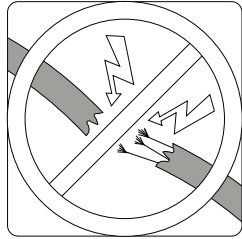

Check for damaged wires

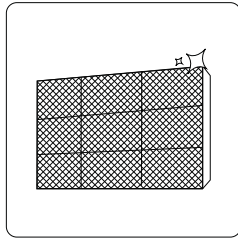

Clean all filters



Check for leaks

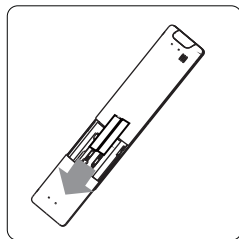

Replace batteries

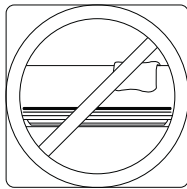

Make sure nothing is blocking all air inlets and outlets



**Fig. 15 — Pre-Season Inspection**

## Preparing for Extended Shutdown Period

Clean the filters and reposition them in the unit. Operate the unit in **FAN ONLY** mode for 12 hours to dry all internal parts. Turn main power supply off and remove batteries from the remote control.

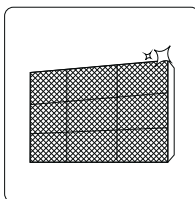

Clean all filters

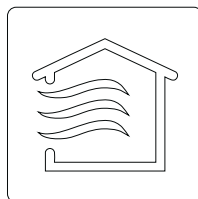

Turn on FAN function until unit dries out completely

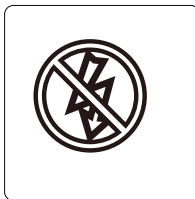

Turn off the unit and disconnect the power

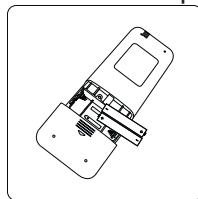

Remove batteries from remote control

**Fig. 16 — Extended Shutdown Period Steps**

## System Operation Recommendations

The items outlined in the following list help to assure proper system operation:

- **Replace both remote control batteries at the same time.**
- **Point the remote control toward the unit display panel when transmitting a command.**
- **Keep doors and windows closed while unit is operating.**
- **Contact an authorized service representative if a problem arises that cannot be easily resolved.**
- **Do not perform cleaning or maintenance activities while the unit is on.**
- **Keep the display panel on the unit away from direct sunlight and heat as this may interfere with remote control transmissions.**
- **Do not block air intakes and outlets on the indoor or outdoor units.**

## Energy Saving Recommendations

The following recommendations will add greater efficiency to the ductless system:

- **Select a comfortable thermostat setting and leave it at chosen setting. Avoid continually raising and lowering the setting.**
- **Keep the filter clean. Frequent cleaning may be necessary depending on indoor air quality.**
- **Use drapes, curtains or shades to keep direct sunlight from heating the room on very hot days.**
- **Limit the unit's run time by using the TIMER function.**
- **Do not obstruct the air intake on the front panel.**
- **Turn on the air conditioning unit before the indoor air becomes too uncomfortable.**

## TROUBLESHOOTING (CONT)

Refer to Table 1 before contacting your local dealer.

**Table 1 — Periodic Maintenance**

INDOOR UNIT	EVERY MONTH	EVERY 6 MONTHS	EVERY YEAR
Clean Air Filter*	•		•
Replace Carbon Filter		•	•
Change Remote Control Batteries (as needed)			
OUTDOOR UNIT	EVERY MONTH	EVERY 6 MONTHS	EVERY YEAR
Clean Outdoor Coil from Outside		•	
Clean Outdoor Coil from Inside†			•
Blow Air Over Electric Parts†			•
Check Electric Connection Tightening†			•
Clean Fan Wheel†			•
Check Fan Tightening†			•
Clean Drain Pans†			•

\* Increase frequency in dusty zones.

† Maintenance to be carried out by qualified service personnel. Refer to the Installation Manual

The following problems are not a malfunction and in most situations will not require repairs.

**Table 2 — Common Issues**

Issue	Possible Causes
Unit does not turn on when pressing <b>ON/OFF</b>	The unit has a 3-minute protection feature that prevents the unit from overloading. The unit cannot restart within three minutes of being turned off.
The unit changes from <b>COOL/HEAT</b> mode to <b>FAN</b> mode	The unit may change its setting to prevent frost from forming on the unit. Once the temperature increases, the unit will start operating in the previously selected mode. The set temperature has been reached, at which point the unit turns off the compressor. The unit will continue operating once the temperature fluctuates again.
The indoor unit emits white mist	In humid regions, a large temperature difference between the room's air and the conditioned air can cause white mist.
Both the indoor and outdoor units emit white mist	When the unit restarts in <b>HEAT</b> mode after defrosting, white mist may be emitted due to moisture generated from the defrosting process.
The indoor unit makes noises	A rushing air sound may occur when the louver resets its position. A squeaking sound may occur after running the unit in <b>HEAT</b> mode due to expansion and contraction of the unit's plastic parts.
Both the indoor unit and outdoor unit make noises	<b>Low hissing sound during operation:</b> This is normal and is caused by refrigerant gas flowing through both indoor and outdoor units. <b>Low hissing sound when the system starts, has just stopped running, or is defrosting: This noise is normal and is caused by the refrigerant gas stopping or changing direction.</b> <b>Squeaking sound:</b> Normal expansion and contraction of plastic and metal parts caused by temperature changes during operation can cause squeaking noises.
The outdoor unit makes noises	The unit makes different sounds based on its current operating mode.
Dust is emitted from either the indoor or outdoor unit	The unit may accumulate dust during extended periods of non-use, which will be emitted when the unit is turned on. This can be mitigated by covering the unit during long periods of inactivity.
The unit emits a bad odor	The unit may absorb odors from the environment (such as furniture, cooking, cigarettes, etc.) which will be emitted during operations. The unit's filters have become moldy and should be cleaned.
The outdoor unit fan does not operate	During operation, the fan speed is controlled to optimize product operation.
Operation is erratic, unpredictable, or unit is unresponsive	Interference from cell phone towers and remote boosters may cause the unit to malfunction. In this case, try the following: <ul style="list-style-type: none"> <li>• Disconnect the power, then reconnect.</li> <li>• Press <b>ON/OFF</b> on the remote control to restart the operation.</li> </ul>

## TROUBLESHOOTING (CONT)

**Table 3 — Troubleshooting**

<b>PROBLEM</b>	<b>POSSIBLE CAUSE</b>	<b>SOLUTION</b>
Unit/System Does Not Work	<ul style="list-style-type: none"> <li>• The circuit breaker has tripped or a fuse has blown.</li> <li>• Diagnostic lights illuminate.*</li> <li>• Voltage is too low.</li> </ul>	<ul style="list-style-type: none"> <li>• Reset the circuit breaker or replace the fuse with the specified replacement fuse.</li> <li>• Call your service representative.</li> <li>• Call your service representative.</li> </ul>
Cooling is Not Working Properly	<ul style="list-style-type: none"> <li>• The filter is blocked by dust.</li> <li>• Temperature is not set properly.</li> <li>• A window or door is open.</li> <li>• The outdoor unit is obstructed.</li> <li>• The fan speed is too low.</li> <li>• The operation mode is in Fan instead of Cool.</li> </ul>	<ul style="list-style-type: none"> <li>• Clean the air filter.</li> <li>• Check the temperature and reset if necessary.</li> <li>• Close the window or door.</li> <li>• Remove the obstruction.</li> <li>• Change the fan speed selection.</li> <li>• Change the operating mode to Cool or reset the unit.</li> </ul>
Heating is Not Working Properly	<ul style="list-style-type: none"> <li>• The filter is blocked with dust.</li> <li>• Temperature is set too low.</li> <li>• A window or door is open.</li> <li>• The outdoor unit is obstructed.</li> </ul>	<ul style="list-style-type: none"> <li>• Check the temperature and reset if necessary.</li> <li>• Close the window or door.</li> <li>• Remove the obstruction.</li> </ul>
Unit Stops During Operation	<ul style="list-style-type: none"> <li>• The Off timer is not operating correctly.</li> <li>• Diagnostic lights illuminate.*</li> </ul>	<ul style="list-style-type: none"> <li>• Restart the operating mode.</li> <li>• Call your service representative.</li> </ul>

\* Diagnostic lights are a combination of lights that will illuminate in the display area on the unit. They are a combination of the lights you see during normal operation.